



AL-MAHDI INTERNATIONAL
we serve to save lives



Address: Bonken Road Near Madina Masjid Pacca
Garha P.O. Box 1424, Sialkot-Pakistan.

Email: info@almahdi-intl.com
almahdi.intl@gmail.com

Website: www.almahdi-intl.com

Skype: Al-Mahdi International

Mob/Whatsapp: +92 320 1412575

Percussion Hammers and Aesthesiometers



01-101
TROEMNER
Size: 245 mm



01-102
DEJERINE
Size: 200 mm



01-103
DEJERINE
with needle
Size: 210 mm



01-104
TAYLOR
Size: 195 mm



01-105
BERLINER
Size: 200 mm



01-106
BUCK
with needle
and brush
Size: 180 mm



01-107
RABINER
with needle
and brush
Size: 255 mm



01-108
ALY
Size: 190 mm



01-109
WARTENBERG
Pinwheel for
neurological
examination
Size: 185 mm

Stethoscopes



01-110
PINARD (Aluminum)
Size: 155 mm

1/2



01-111
wooden
Size: 145 mm

1/2



01-112
BOWLES
Stethoscope
with diaphragm

1/4



01-113
ANESTOPHON

1/2



01-114
FORD-BOWLES
Dual chest piece
with two outlets

1/4



01-115
BOWLES

1/4

Head Mirrors and Head Bands



01-116
ZIEGLER \varnothing 90mm
head mirror only
with rubber coating



01-117
ZIEGLER \varnothing 90mm
head mirror only
with metal coating



01-118
ZIEGLER
head band of plastic black

01-119
ZIEGLER
head band of plastic white



01-120
MURPHY
head band of celluloid, white



01-121
head band of plastic,
white, soft pattern



01-122
head mirror with black
plastic head band.

Tongue Depressors

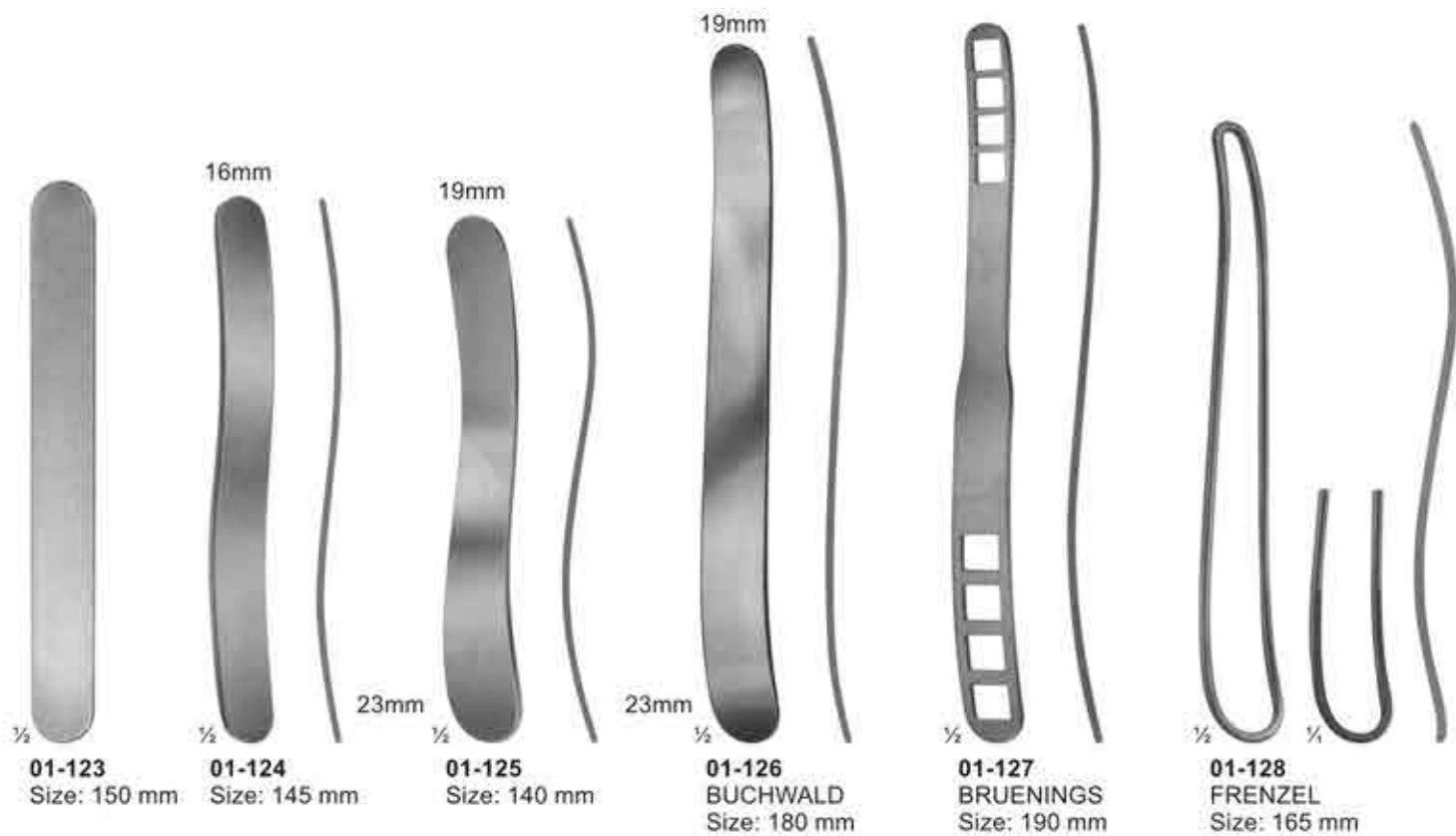

Instruments for Anaesthesia and Tongue Forceps



1/2
01-134
SCHIMMELBUSCH
Ether mask



1/2
01-135
HEISTER
Mouth gag
Size: 130 mm



1/2
01-136
FERGUSSON-ACKLAND
Mouth gag
Size: 145 mm



1/2
01-137
DENHARDT
Mouth gag with silicon
inserts, interchangeable
Size: 125 mm



1/2
01-138
ROSER KOENIG
Mouth gag
Size: 160 mm, 185 mm



1/2
01-139
YOUNG
Size: 165 mm



1/2
1 Pair Of
Rubber Pads

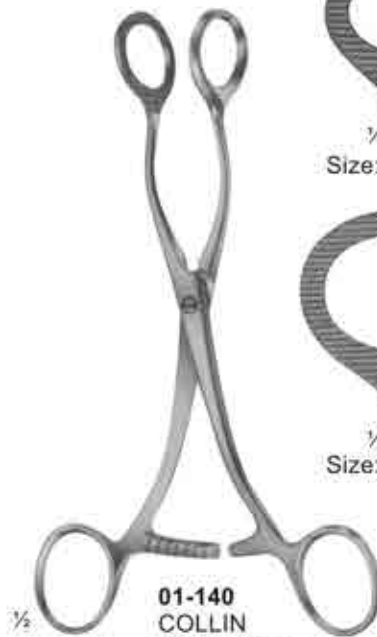

1/2
01-140
COLLIN
Size: 160 mm,
170 mm



1/2
Size: 160 mm



1/2
Size: 170 mm



1/2
01-141
HEYWOOD-SMITH
modif. Size: 215 mm

Blood Lancets and Laryngeal Mirrors

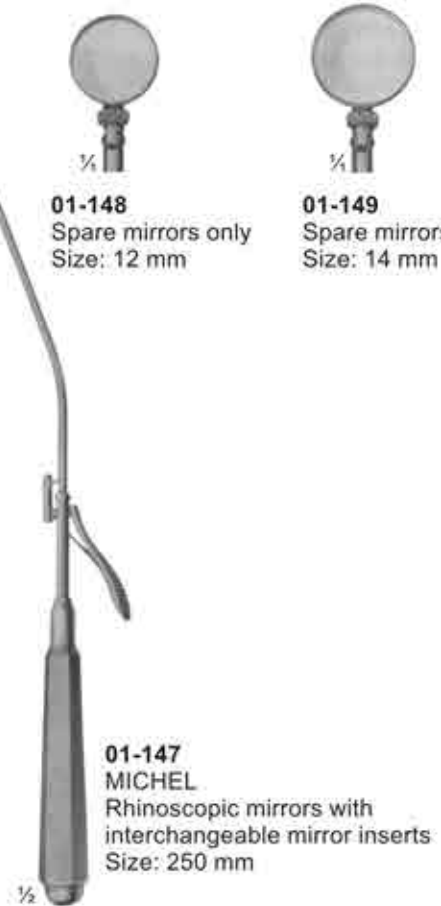
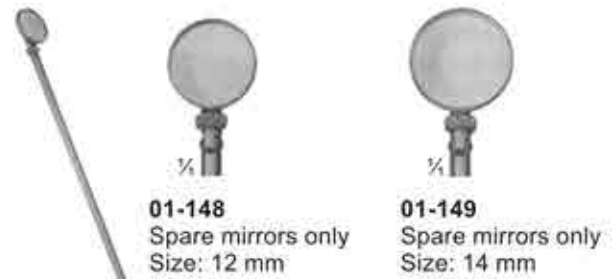
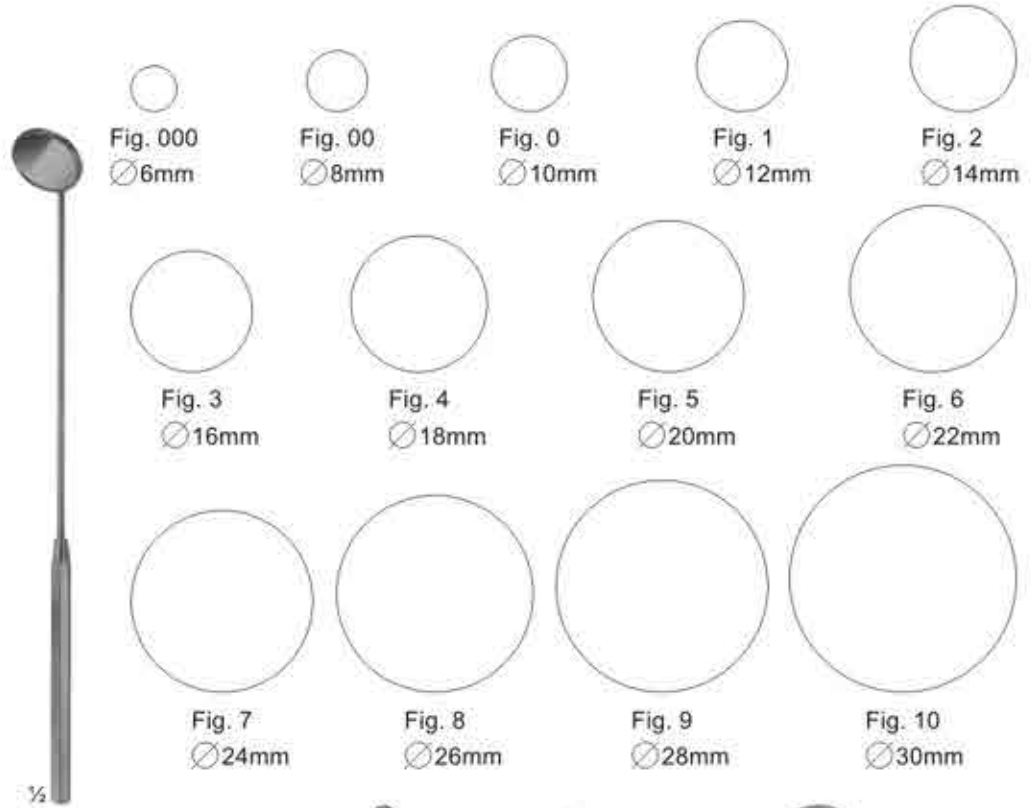

Laryngoscope and Diagnostic Sets



01-150
Infants
Size: 150 mm



01-151
Children
Size: 200 mm



01-152
Adults
Size: 250 mm



01-150 - 152
MAGILL



01-153
Medium battery handle
only, 25 mm diam.



01-153-A
Spare bulb
2.7 volt, for
otoscopes



01-153-B
Spare bulb
2.6 volt, for
ophthalmoscopes



01-154



01-155



01-156
Otoscope set, consists of
battery handle without batteries,
3 ear specula, 1 bulb in valvet lined case



01-157
Diagnostic set, otoscope with three specula,
nasal speculum, lamp holder, two laryngeal
mirrors, tongue blade holder.

Laryngoscopes



01-158
MILLER
 Laryngoscope set, consists of battery handle (without battery)
 with four miller laryngoscope blades

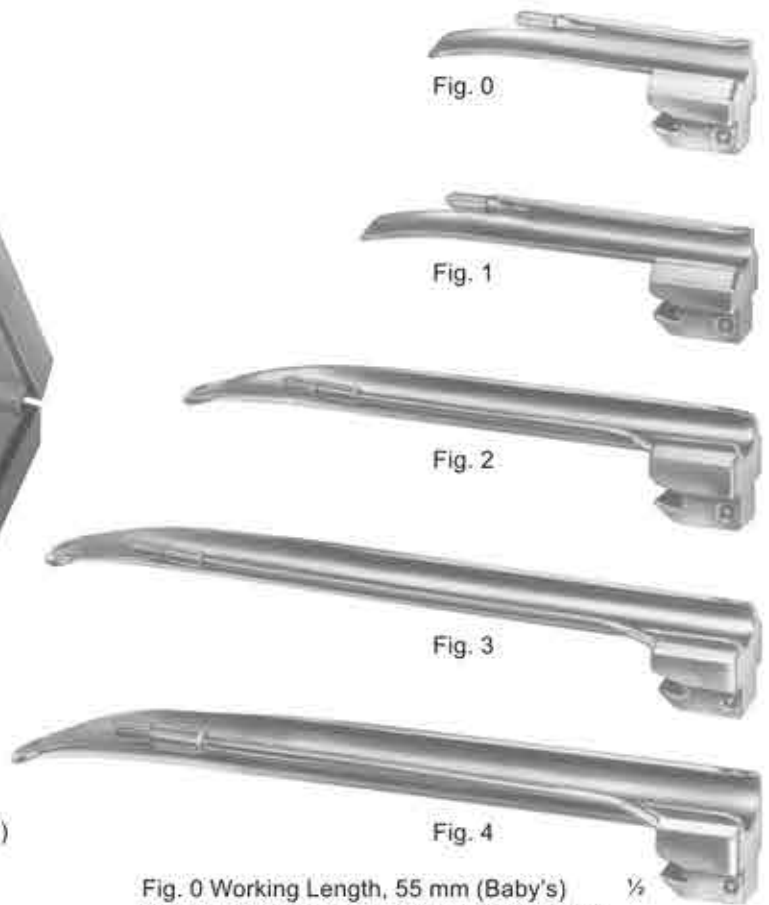

Fig. 0 Working Length, 55 mm (Baby's) $\frac{1}{2}$
 Fig. 1 Working Length, 80 mm (Children's)
 Fig. 2 Working Length, 130 mm (Adolescent's)
 Fig. 3 Working Length, 170 mm (Women's)
 Fig. 4 Working Length, 180 mm (Men's)



01-159
GUEDEL-NEGUS
 Laryngoscope set, consists of battery handle (without battery)
 with four miller laryngoscope blades



Fig. 1 Working Length, 70 mm (Children's)
 Fig. 2 Working Length, 90 mm (Adolescent's)
 Fig. 3 Working Length, 110 mm (Women's)
 Fig. 4 Working Length, 135 mm (Men's)

Laryngoscopes



01-160
McINTOSH
 Laryngoscope Set, Consists Of Battery Handle (Without Battery)
 With Three McIntosh Blades, Fig. 1, Fig. 2, Fig. 3

01-161
McINTOSH
 Laryngoscope Set, Consists Of Battery Handle (Without Battery)
 With Five McIntosh Blades, Fig. 0, Fig. 1, Fig. 2, Fig. 3, Fig. 4



Fig. 0



Fig. 1



Fig. 2



Fig. 3



Fig. 4

01-161 A Fig. 0 Working Length, 55 mm (Baby's)
 01-161 B Fig. 1 Working Length, 75 mm (Children's)
 01-161 C Fig. 2 Working Length, 90 mm (Adolescent's)
 01-161 D Fig. 3 Working Length, 110 mm (Women's)
 01-161 E Fig. 4 Working Length, 135 mm (Men's)

01-162
FOREGGER
 Laryngoscope Set, Consists Of
 Battery Handle (Without Battery)
 With Three Foregger Blades,
 Fig. 1, Fig. 2, Fig. 3,



01-163
FOREGGER
 Laryngoscope Set, Consists Of
 Battery Handle (Without Battery)
 With Four Foregger Blades,
 Fig. 1, Fig. 2, Fig. 3, Fig. 4.



Fig. 1



Fig. 2



Fig. 3



Fig. 4

01-162 A Fig. 1 Working Length, 70 mm (Children's)
 01-162 B Fig. 2 Working Length, 90 mm (Adolescent's)
 01-162 C Fig. 3 Working Length, 110 mm (Women's)
 01-162 D Fig. 4 Working Length, 135 mm (Men's)



01-164
 Fiber Optic
 Battery Handle
 30mm diam.



01-165
 Fiber Optic
 Battery Handle
 18mm diam.



01-166
 Replacement Lamp
 (Krypton) 2.5 V



01-167
 Replacement Lamp
 (Halogen) 2.5 V

Examination & Measuring Instruments

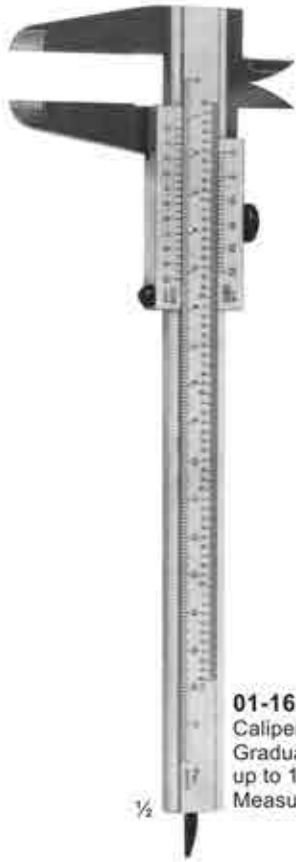

01-168
 Caliper Of Aluminium
 Graduated in mm & inches
 up to 180mm
 Measuring Range up to 139mm



01-169
 VERNIER
 Universal Caliper Of Steel
 Graduated in mm & inches
 up to 180mm
 Measuring Range up to 120mm
 with Vernier in 1/10mm & 1/16"



01-170
 CARROLL
 Size: 145 mm
 Finger Goniometer



01-171
 TOWNLEY
 Graduated in
 mm & inches
 Size: 115 mm



01-172
 COLLIN
 Druck Pressure 72 kg
 Size: 125 mm



01-173
 BERTILLON
 Caliper For Measuring The Head
 Size: 320 mm



01-174
 CASTROVIEJO
 Caliper
 Size: 75mm



01-175
 MOLTGEN
 Goniometer



01-176
 Size: 150 mm



01-177
 Size: 500 mm

Dissecting Knives



1/2
02-101 - 110
 Fig. 1 - 10



02-101
 Fig. 1
 30 mm



02-102
 Fig. 2
 36 mm



02-103
 Fig. 3
 40 mm



02-104
 Fig. 4
 45 mm



02-105
 Fig. 5
 50 mm



02-106
 Fig. 6
 27 mm



02-107
 Fig. 7
 35 mm



02-108
 Fig. 8
 40 mm



02-109
 Fig. 9
 47 mm



02-110
 Fig. 10
 50 mm

Amputating Knives, Cartilage Knives and Autopsy Knives



LISTON 02-111 Size: 130 mm	02-115 CATLIN Size: 160 mm	02-116 LANGENBECK Size: 120 mm	02-117 Size: 110 mm Blade length Interosseous Knives	02-118 Size: 55 mm Blade length with raspatory, Wooden handle	02-119 Size: 70 mm Blade length Wooden handle	02-120 Size: 80 mm Blade length Metal handle	02-121 Size: 195 mm Blade length Metal handle
----------------------------------	----------------------------------	--------------------------------------	--	---	--	---	--

Blade length
Amputating Knives

Cone Knives, Myomatome, Trigeminal and Tonsil Knives



02-122
AYRE
 Size: 235 mm
 Cone Knife

02-123
 Size: 230 mm
 Cone Knife

02-124
SEGOND
 Size: 270 mm
 Myomatome

02-125
OLIVECRONA
 Size: 205 mm
 Trigeminal
 Knife

02-126
 Size: 230 mm
 Trigeminal
 Knife

02-127
FOWLER
 Size: 200 mm
 Tonsil Knife

02-128
ABRAHAM
 Size: 215 mm
 Tonsil Knife

02-129
BRUNINGS
 Size: 215 mm
 Tonsil Knife

Scalpel Handles

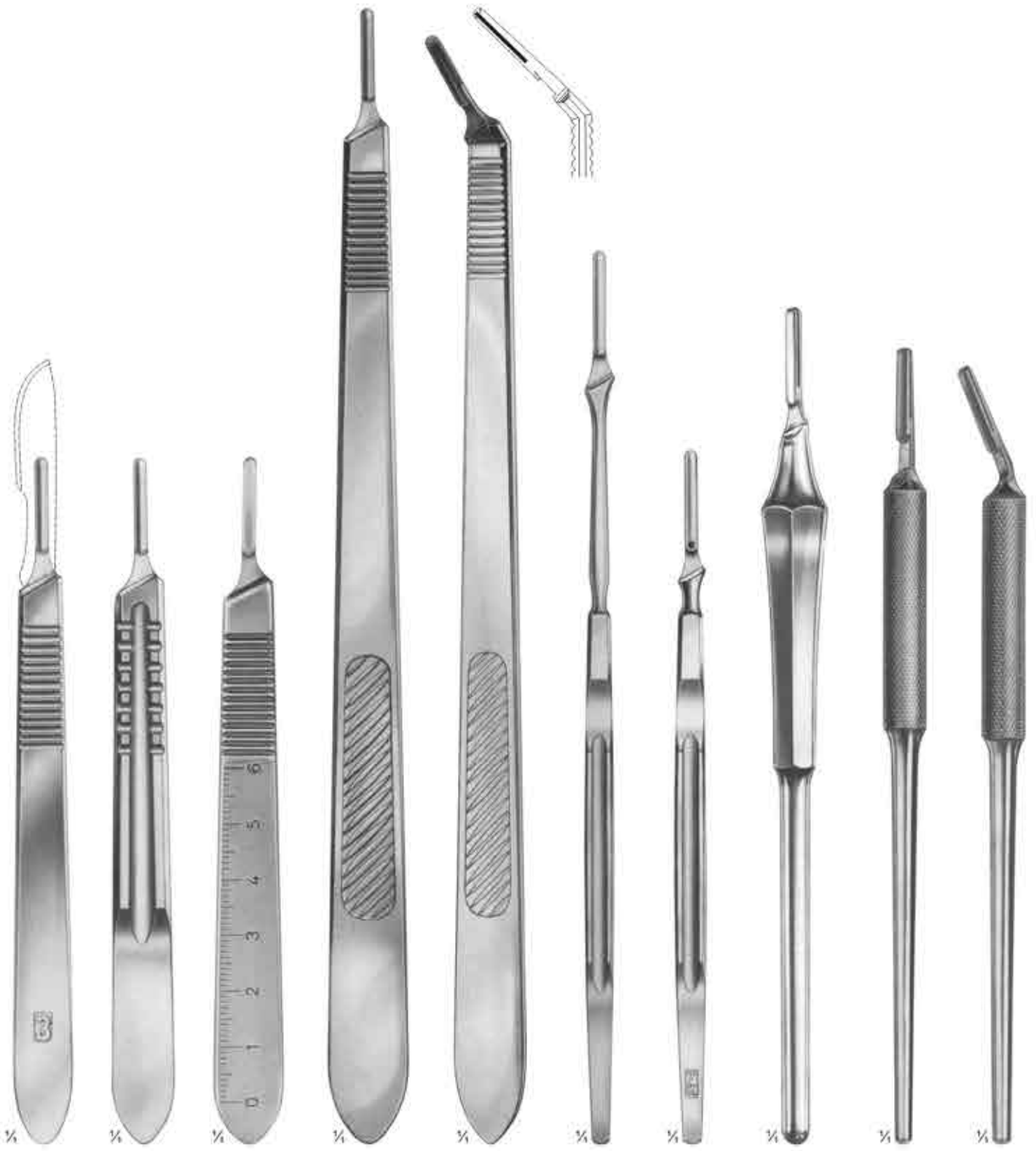

<p>02-130 STANDARD No. 3 Solid 12 cm</p>	<p>02-131 No. 3 Solid 12 cm</p>	<p>02-132 No. 3 Solid 12 cm</p>	<p>02-133 No. 3 L Straight Solid 21.5 cm</p>	<p>02-134 No. 3 L Angled Solid 21 cm</p>	<p>02-135 No. 7 Solid 16 cm</p>	<p>02-136 No. 7 K Solid 12.5 cm</p>	<p>02-137 Hollow-Round 15.5 cm</p>	<p>02-138 No. 3 Straight Solid, Round 14.5 cm</p>	<p>02-139 No. 3 Angled Solid, Round 14 cm</p>
---	--	--	---	---	--	--	---	--	--

Micro Scissors (Spring Type) with Flat Handles

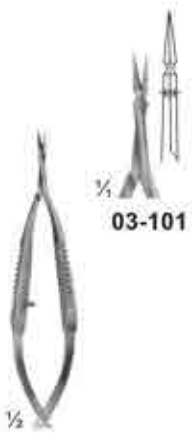

03-101



03-102



03-103

03-101 - 103
VANNAS
Size: 85 mm



03-104



03-105

03-104 - 105
CASTROVIEJO
Size: 95 mm



03-106

03-106
NOYES
Size: 125 mm



03-107



03-108

03-107 - 108
WECKER
Eye scissor
Size: 110 mm



03-109

03-109
CASTROVIEJO
Eye scissor
Size: 115 mm



03-110



03-111

03-110 - 111
CASTROVIEJO
Eye scissor
Size: 110 mm

Micro Scissors (Spring Type) with Flat Handles

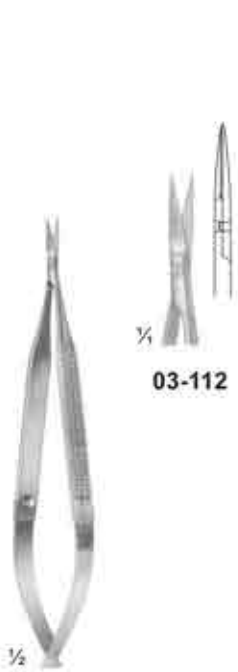

03-112



03-113



03-114
BIEMER
Vein scissor
Size: 130 mm



03-115
Size: 160 mm



03-116

03-117

03-116 - 117
VANNAS
Size: 160 mm

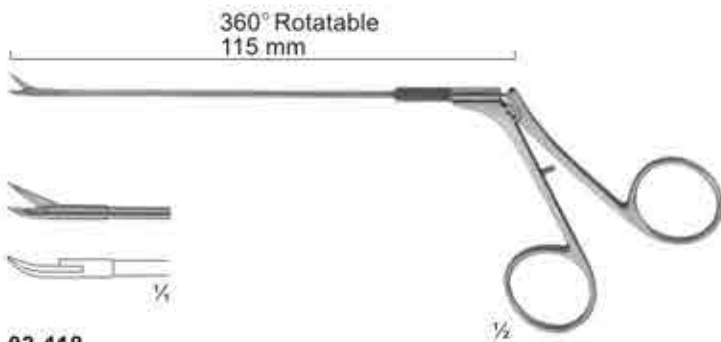

03-118
CASPAR
Micro scissor curved
Size: 115 mm



03-119



03-120



03-121



03-119 - 121
Micro dissecting scissor
Size: 145 mm

Micro Scissors (Spring Type) bayonet-Shaped



1/2
03-122
YASARGIL
 Size: 245 mm



1/2
03-123
 45°



1/2
03-124
 45°



125°



1/2
03-123 - 124
 laterally angled
 Size: 200 mm



1/2
03-126



1/2
03-127



1/2
03-125
 laterally angled
 Size: 190 mm



1/2
03-126 - 127
YASARGIL
 Size: 225 mm

Delicate Scissors



03-128

03-129

03-128 - 129
Size: 90 mm



03-130

03-131

03-130 - 131
Size: 95 mm

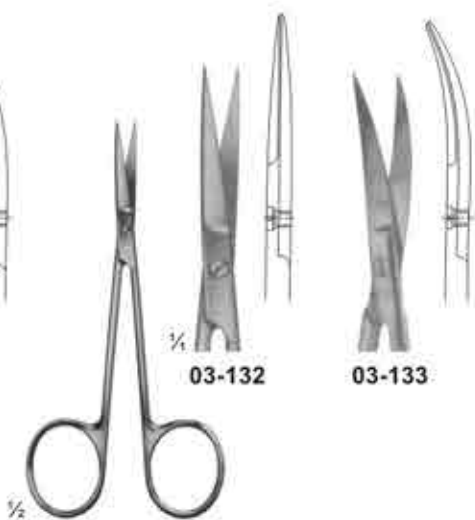

03-132

03-133

03-132 - 133
Size: 105 mm

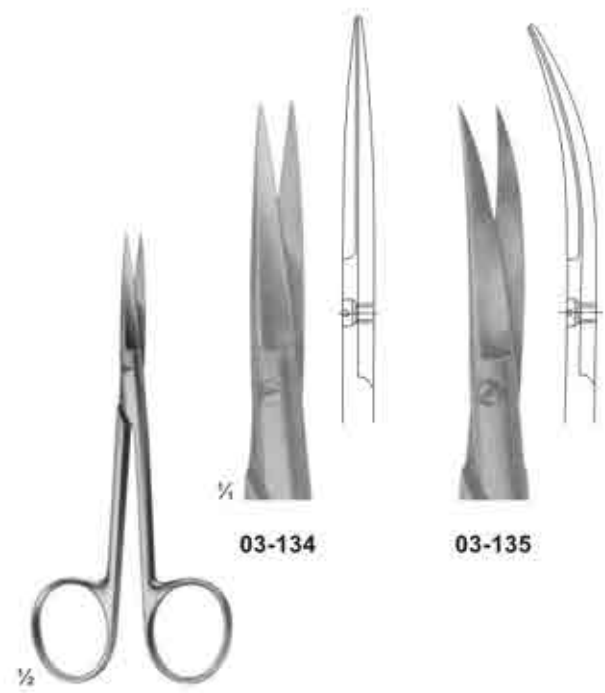

03-134

03-135

03-134 - 135
Size: 120 mm



03-136

03-137

03-136 - 137
Size: 115 mm

Delicate Scissors



03-138 - 140
Size: 120 mm



03-138

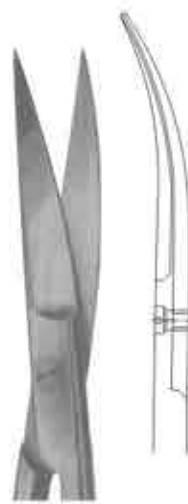

03-139



03-140



03-141 - 144
Size: 130 mm



03-141

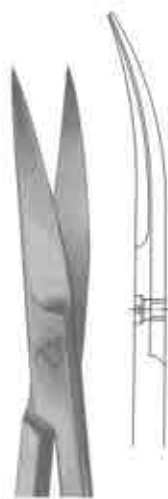

03-142

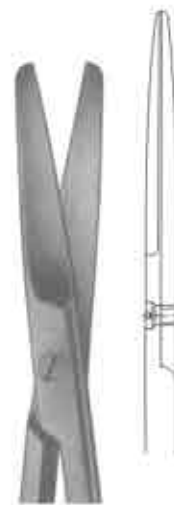

03-143



03-144

Surgical Scissors

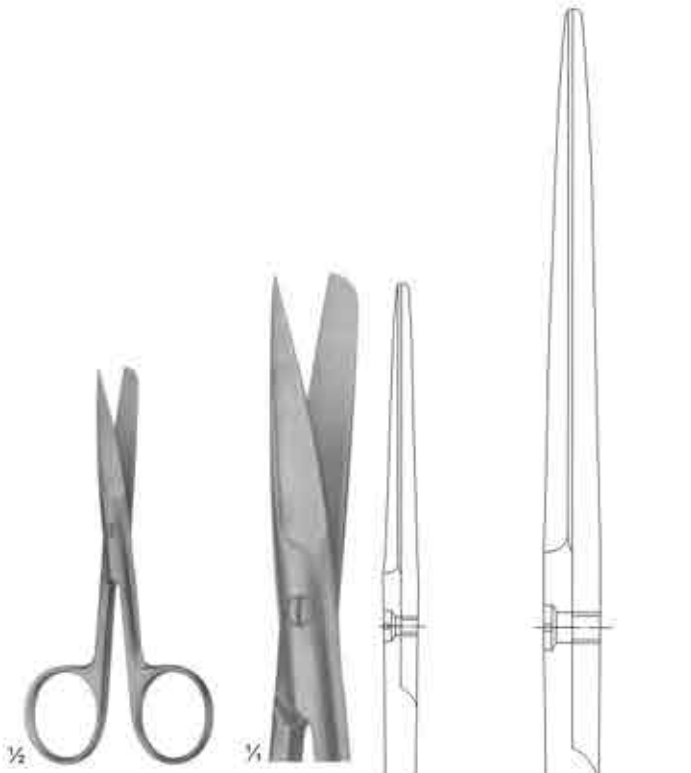

03-145 - 153 (Standard types)
 03-145 (105 mm)
 03-146 (115 mm)
 03-147 (130 mm)
 03-148 (145 mm)
 03-149 (150 mm)
 03-150 (165 mm)
 03-151 (175 mm)
 03-152 (185 mm)
 03-153 (200 mm)

03-145
 Size: 105 mm

03-153
 Size: 200 mm



03-154 - 160 (Standard types)
 03-154 (115 mm)
 03-155 (130 mm)
 03-156 (145 mm)
 03-157 (150 mm)
 03-158 (165 mm)
 03-159 (175 mm)
 03-160 (185 mm)

03-154
 Size: 115 mm

03-160
 Size: 185 mm

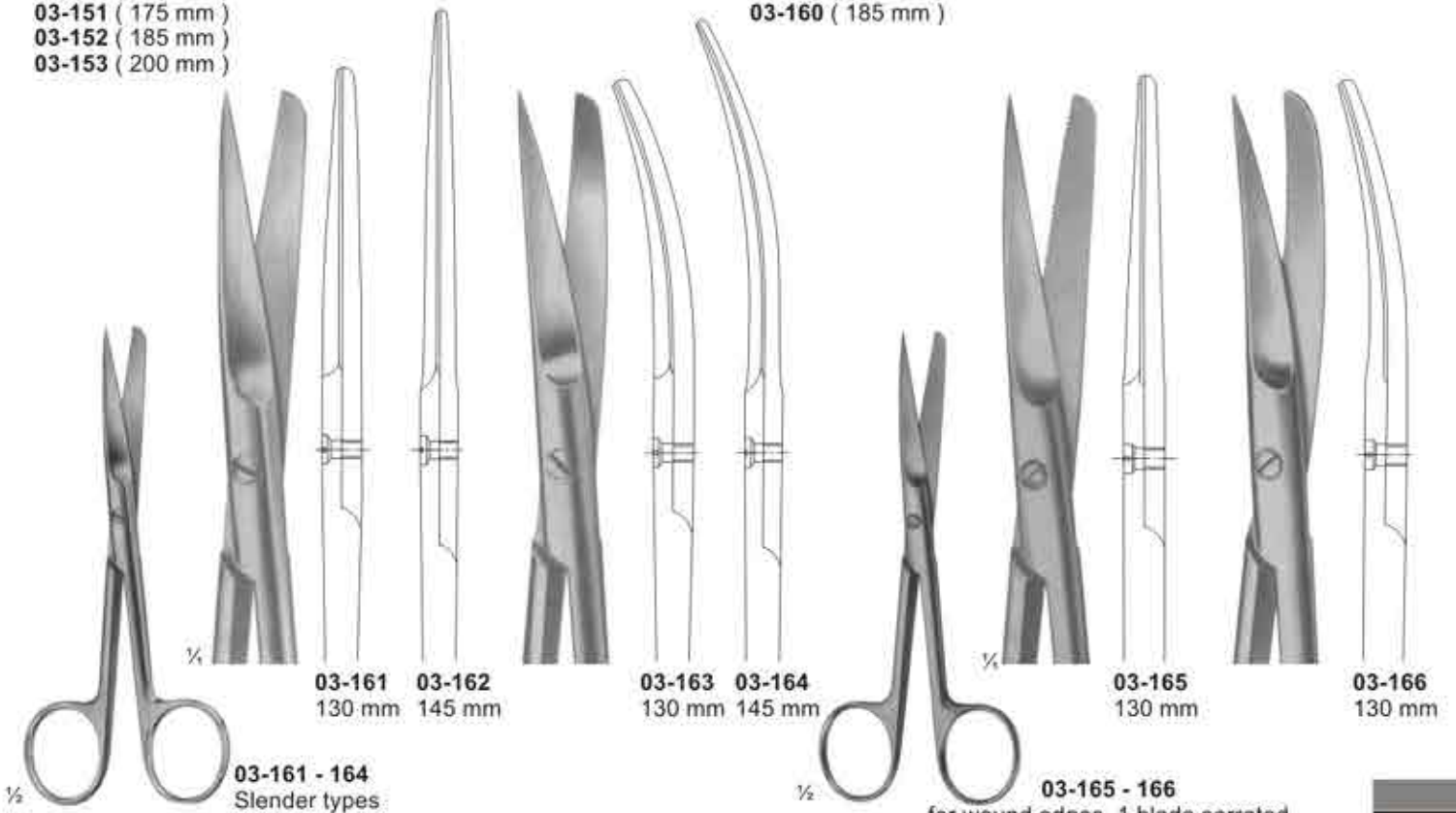

03-161 - 164
 Slender types

03-161 130 mm

03-162 145 mm

03-163 130 mm

03-164 145 mm

03-165 - 166
 for wound edges. 1 blade serrated

03-165 130 mm

03-166 130 mm

Surgical Scissors



03-167 - 169
DEAVER
with flat lock

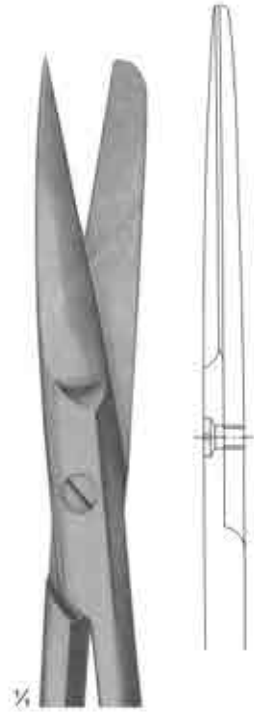

03-167
Size: 145 mm

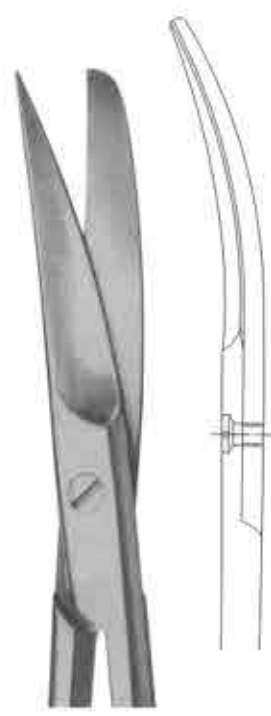

03-168
Size: 145 mm

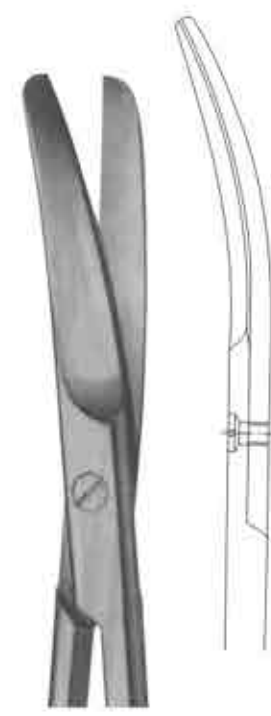

03-169
Size: 145 mm



03-170 - 172
Incision scissors



03-170
Size: 130 mm

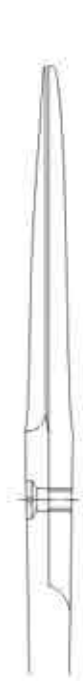

03-171
Size: 145 mm



03-172
Size: 165 mm



03-173
SYSTRUNK
Nail splitting scissors

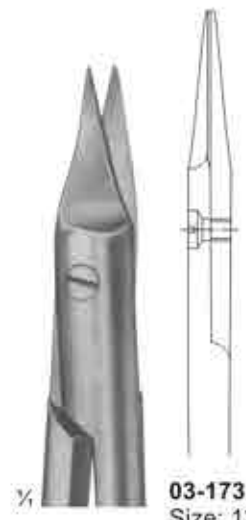

03-173
Size: 130 mm

Dissecting Scissors

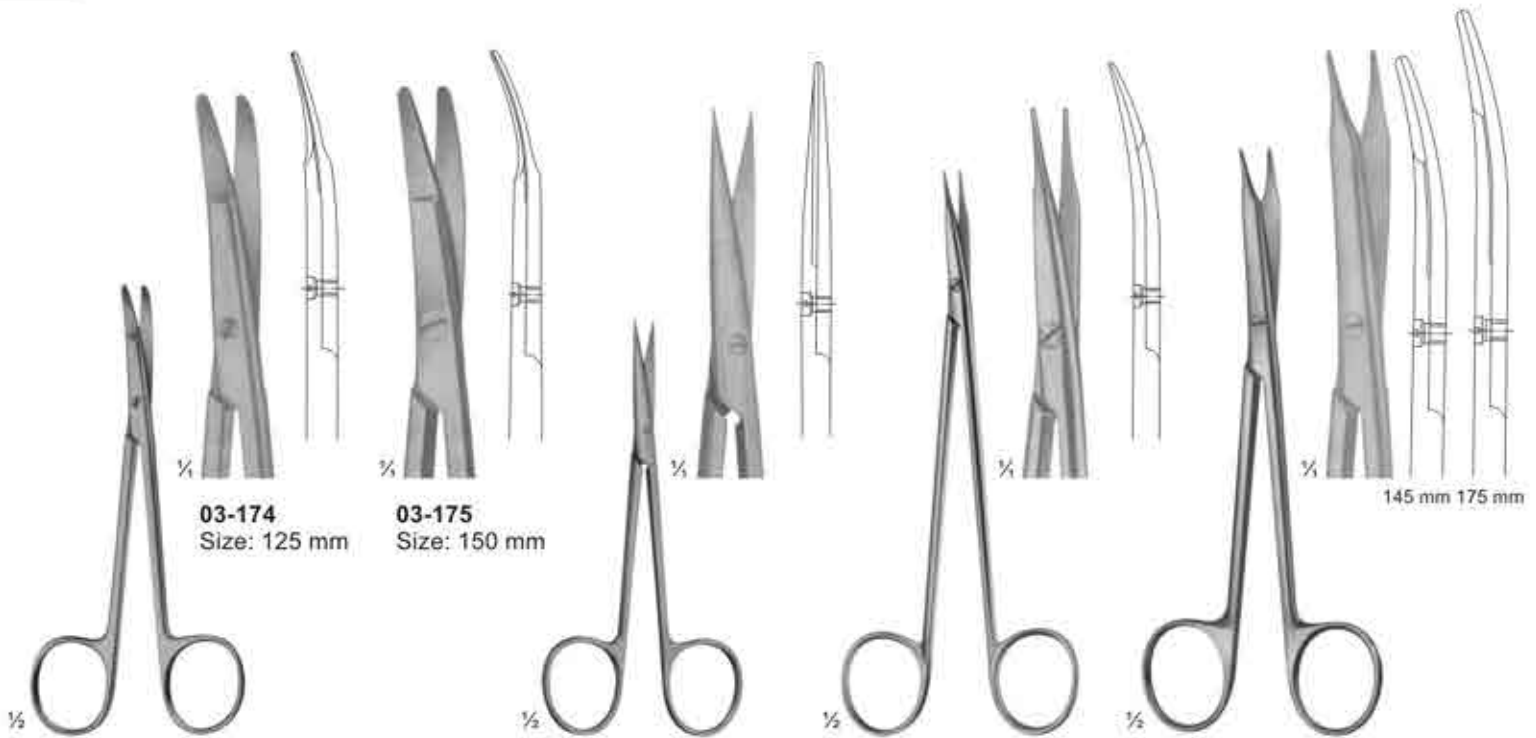

03-174 - 175
KILNER
 Special flat points for dissecting and undermining the skin

03-176
KILNER
 Fine dissecting scissors
 Size: 115 mm

03-177
JAMESON
 Dissecting scissors
 Size: 150 mm

03-178
REYNOLDS
 Dissecting scissors
 Size: 145 - 175 mm

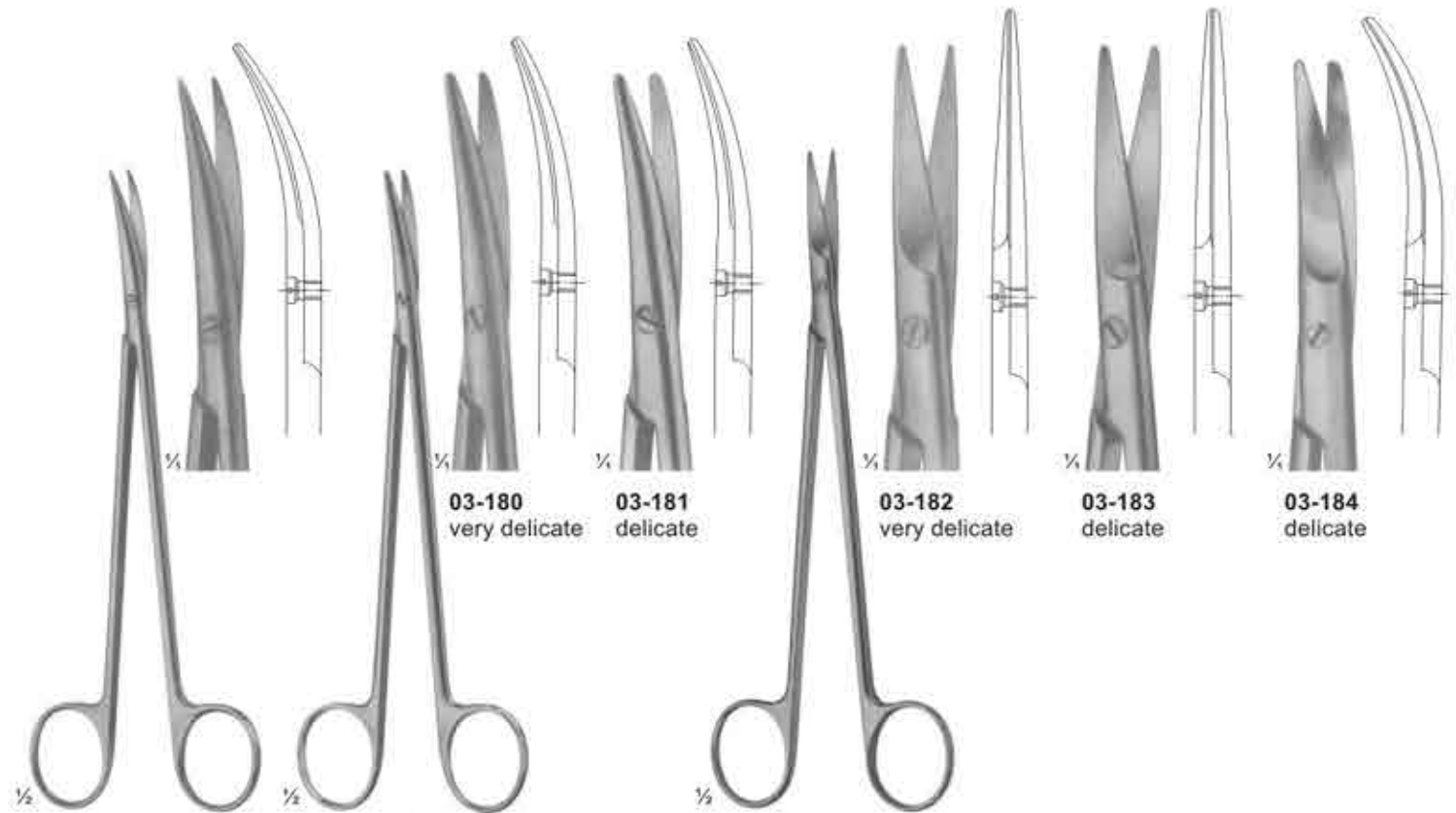

03-179
DE BAKEY
 Arteriotomy scissors
 Size: 175 mm

03-180 - 181
TOENNIS ADSON
 Dissecting scissors
 Size: 175 mm

03-182 - 184
TOENNIS
 Dissecting scissors
 Size: 180 mm

Dissecting Scissors

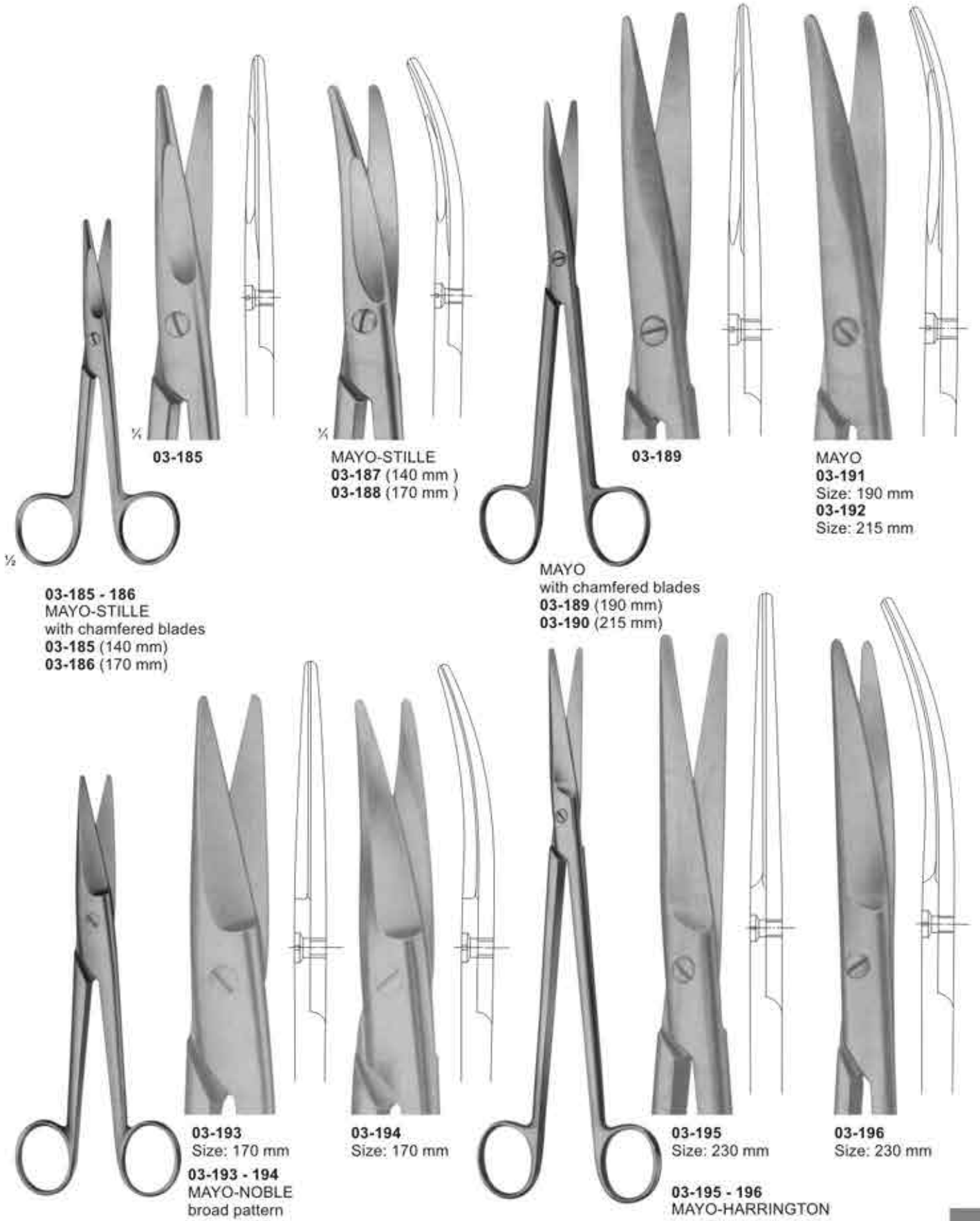

03-185

MAYO-STILLE
03-187 (140 mm)
03-188 (170 mm)

03-189

MAYO
03-191
 Size: 190 mm
03-192
 Size: 215 mm

3/4

03-185 - 186
MAYO-STILLE
 with chamfered blades
03-185 (140 mm)
03-186 (170 mm)

MAYO
 with chamfered blades
03-189 (190 mm)
03-190 (215 mm)

03-193
 Size: 170 mm

03-194
 Size: 170 mm

03-195
 Size: 230 mm

03-196
 Size: 230 mm

03-193 - 194
MAYO-NOBLE
 broad pattern

03-195 - 196
MAYO-HARRINGTON

Scissors for Cardiovascular and Neuro-Surgery



03-197
OLIVECRONA
Dura scissors



03-198
STRULLY
pointed
Size: 220 mm

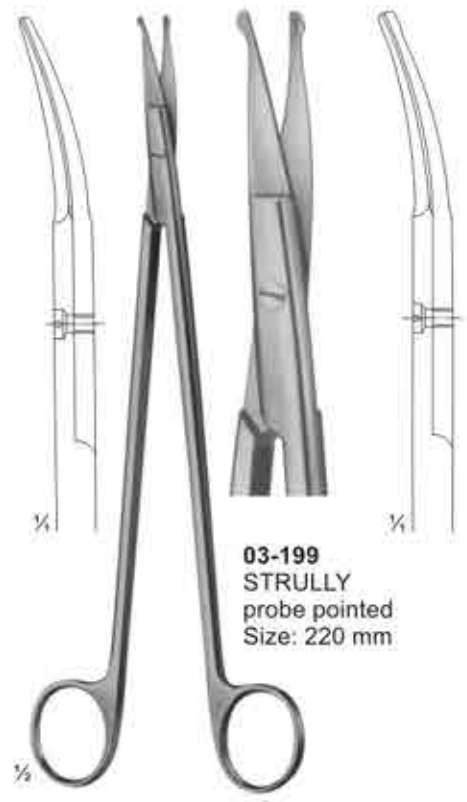

03-199
STRULLY
probe pointed
Size: 220 mm

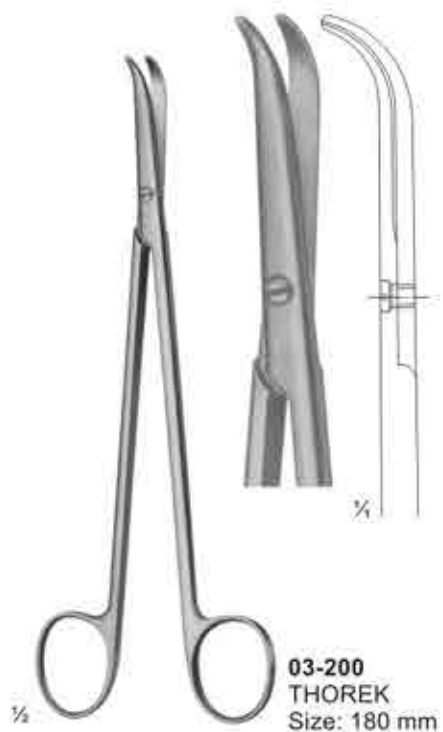

03-200
THOREK
Size: 180 mm

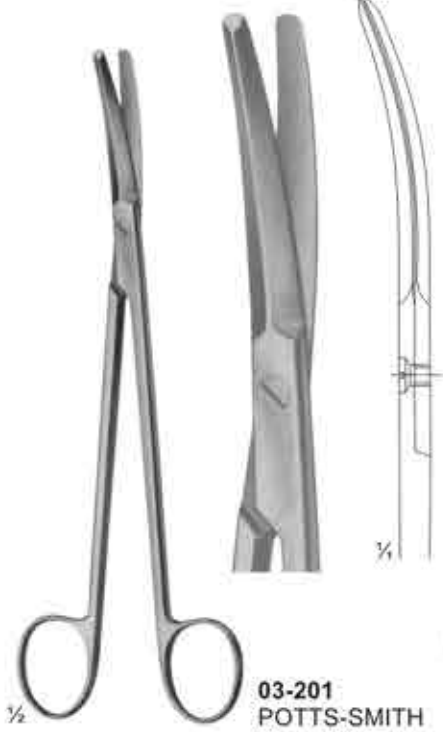

03-201
POTTS-SMITH
Size: 190 mm

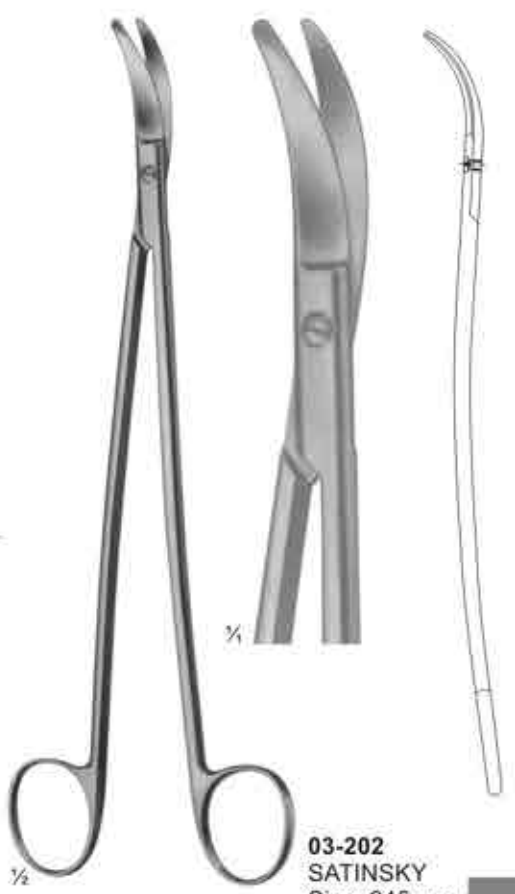

03-202
SATINSKY
Size: 245 mm

Delicate, Nasal and Tonsil Scissors

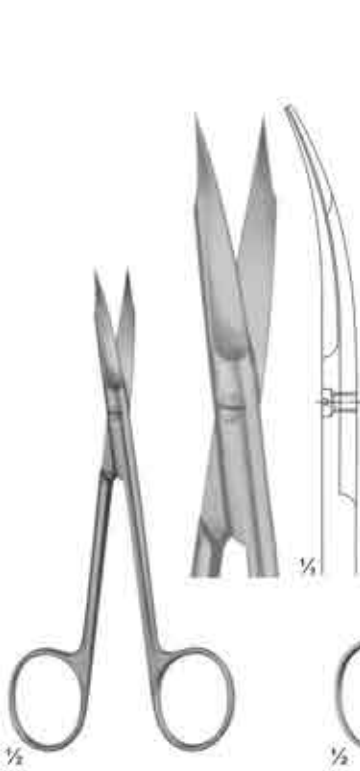

03-203
1 finely toothed blade
Size: 130 mm

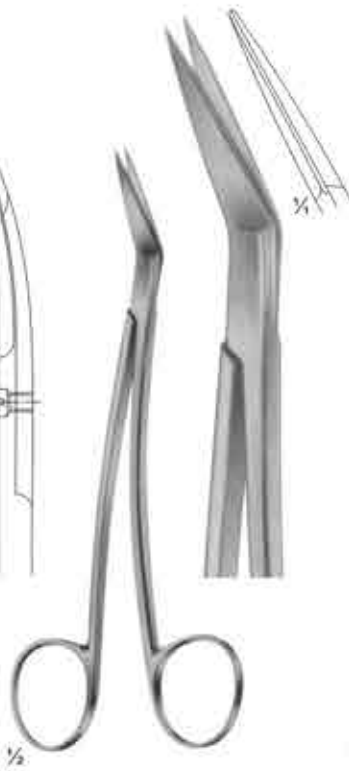

03-204
LOCKLIN
curved sideways,
1 toothed blade
Size: 155 mm



03-205
FOMON
blades serrated
Size: 145 mm

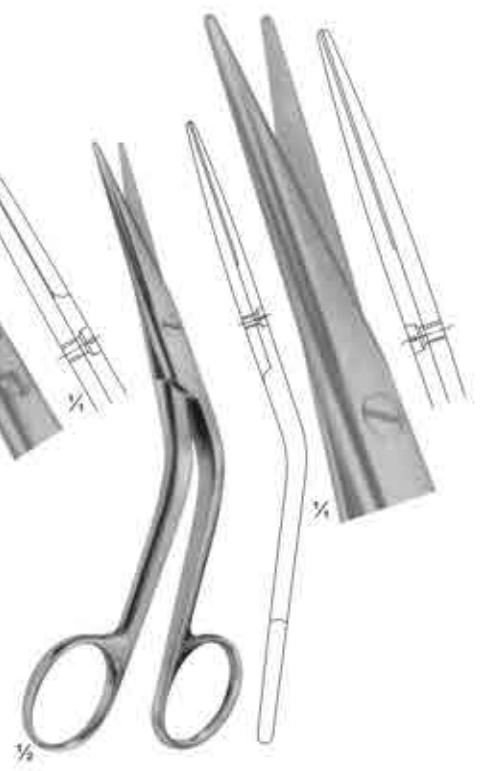

03-206
COTTLE
Size: 165 mm



03-207
HEYMANN-KNIGHT
Size: 175 mm

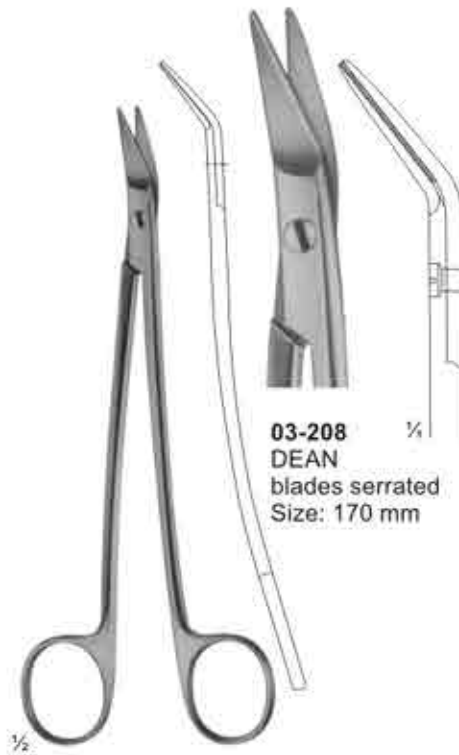

03-208
DEAN
blades serrated
Size: 170 mm

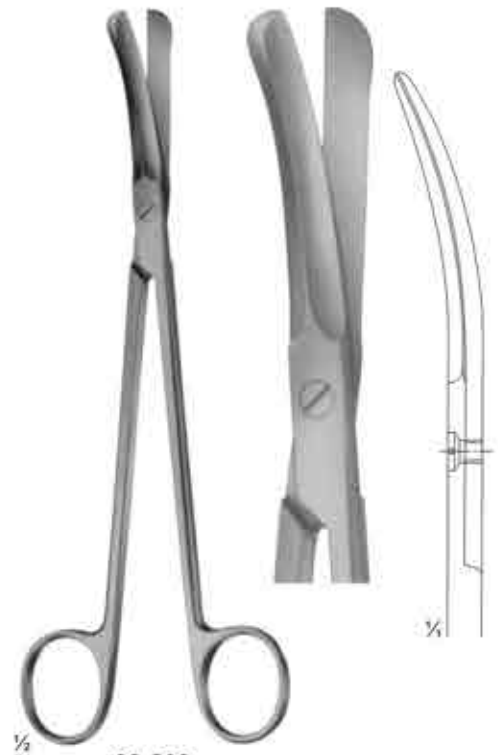

03-209
GOOD
Size: 195 mm

Bone Shears

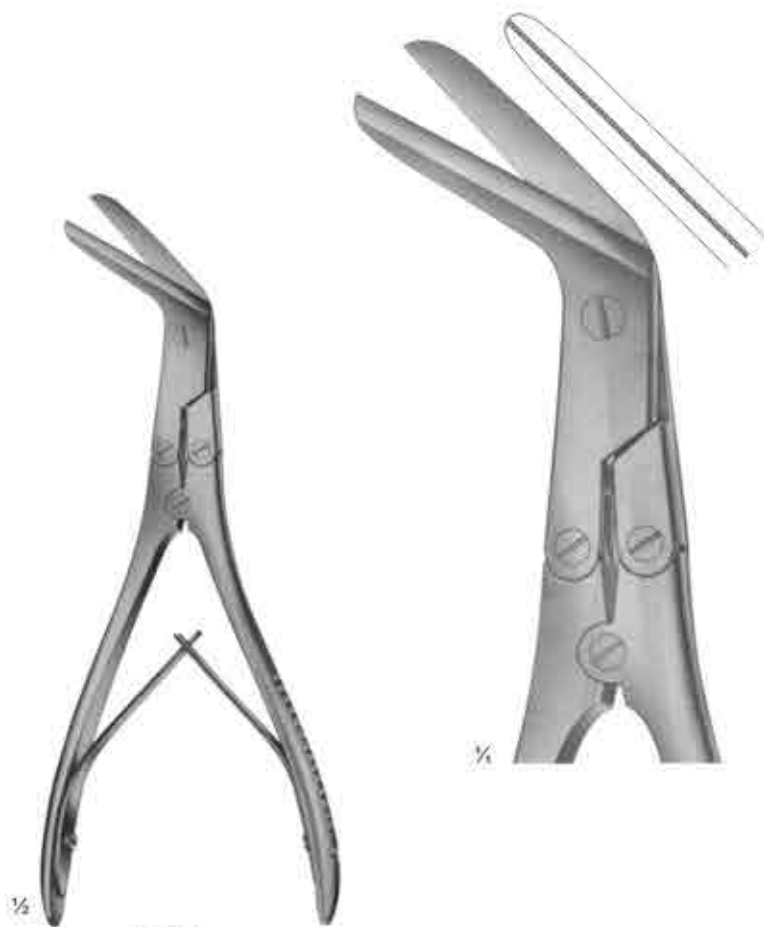

03-210
KILLIAN
Size: 200 mm



03-211 - 03-212



03-211
195 mm



1/2



03-212
225 mm



1/2

**Scissors for deep operations and
for Gynaecology**

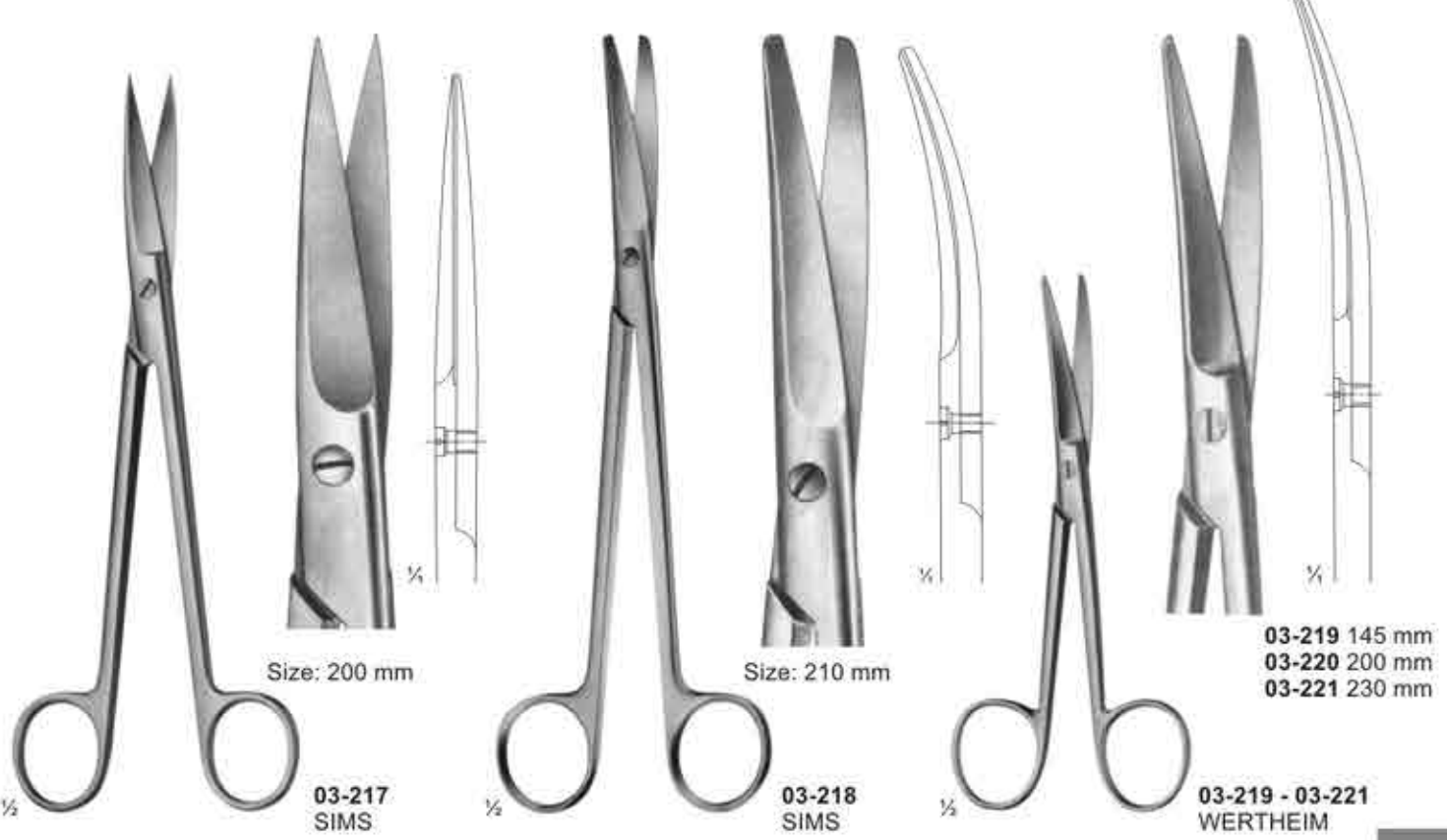
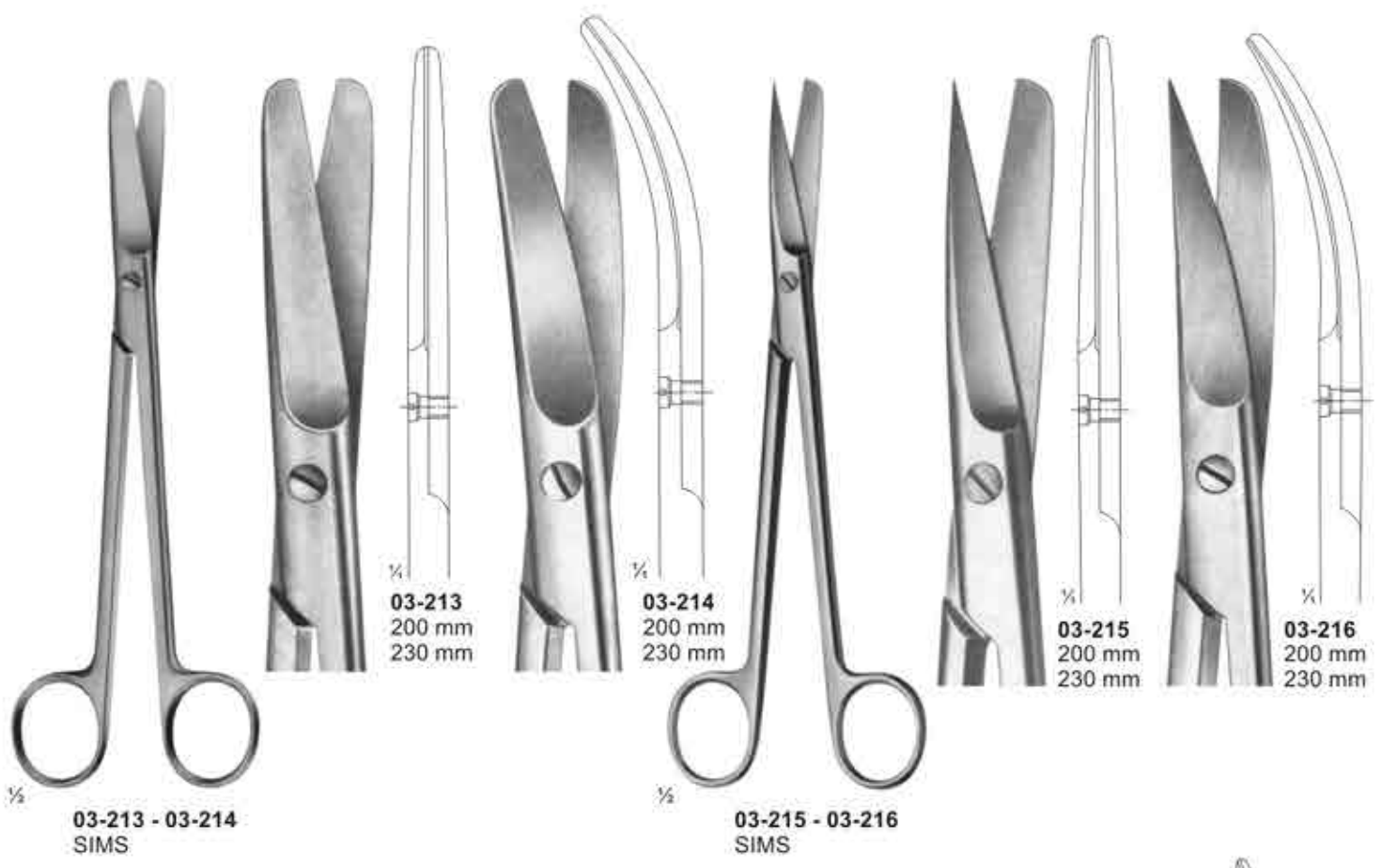

Scissors for Obstetrics



03-222
SCHUMACHER
 Umbilical cord scissors
 Size: 155 mm

03-223
 Umbilical cord scissors
 Size: 105 mm

03-224
 Umbilical cord scissors

135 mm

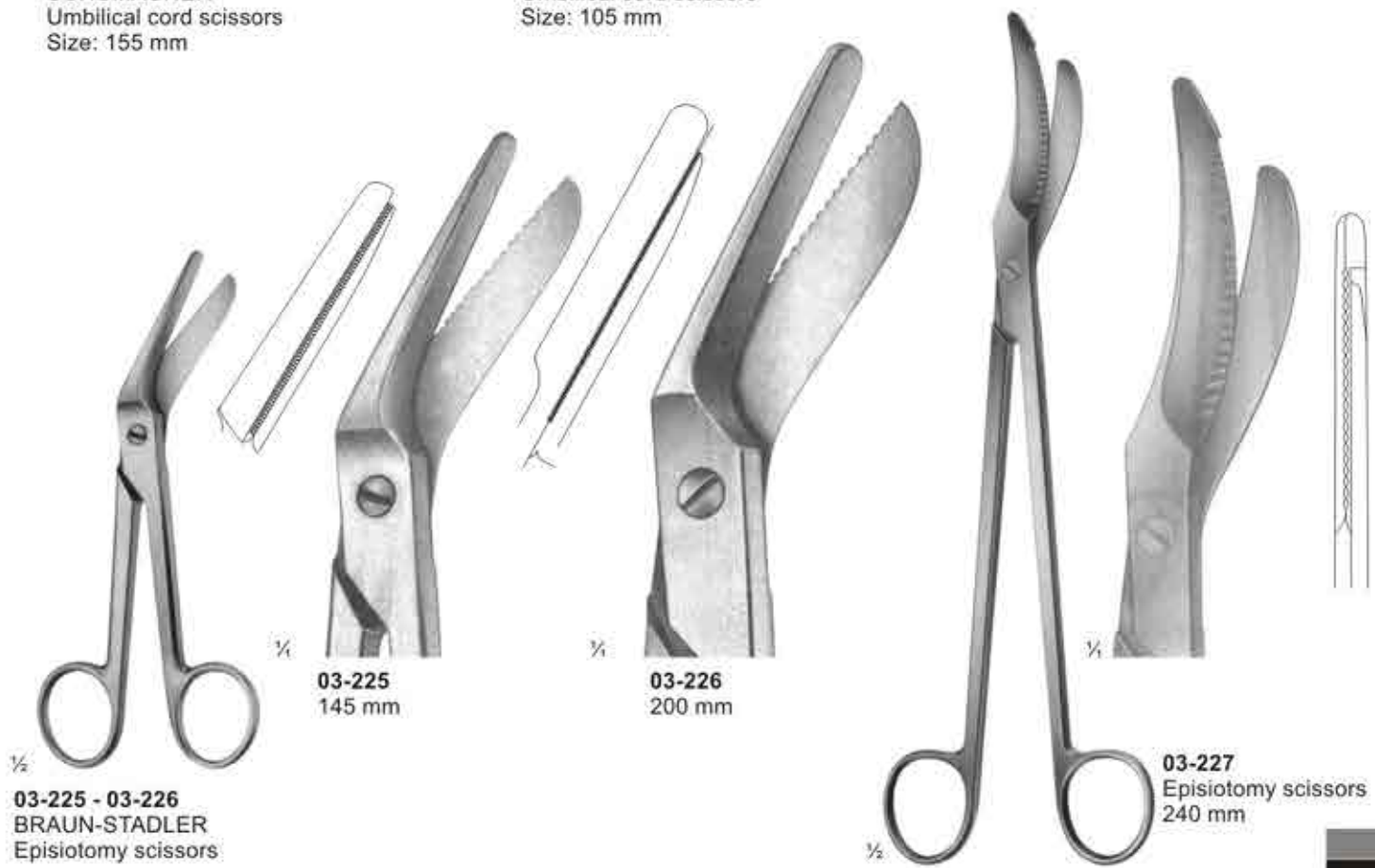

03-225 - 03-226
BRAUN-STADLER
 Episiotomy scissors

03-225
 145 mm

03-226
 200 mm

03-227
 Episiotomy scissors
 240 mm

Wire and Plate Scissors



1/2

03-228 - 03-232
BEEBE
Size: 110 mm

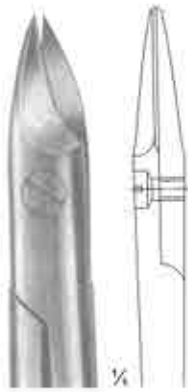

03-228

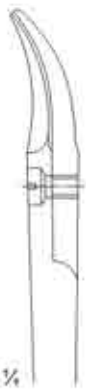

03-229

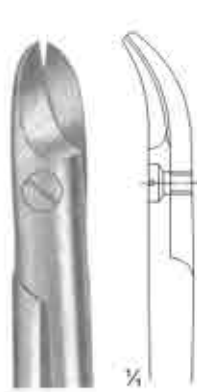

03-230
broad blades

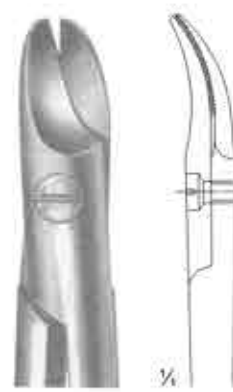

03-231
1 blade serrated



03-232
NAUJOKS
strongly curved

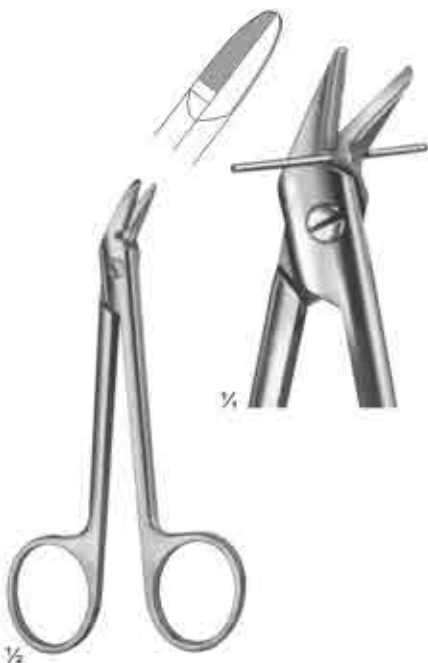

1/2

03-233
1 blade serrated
Size: 120 mm



1/2

03-234
STRACK
Size: 100 mm



1/2

03-235
HARVEY
blades serrated
Size: 125 mm

Bandage and Cloth Scissors



03-236
Universal bandage and cloth scissors,
with toothed edges
180 mm

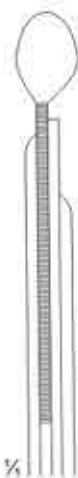

03-237
LISTER
Universal bandage and cloth scissors,
with toothed edges
Size: 145 mm

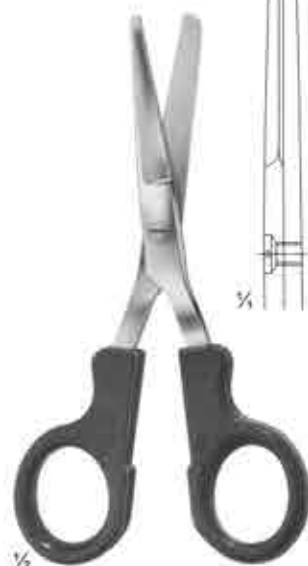
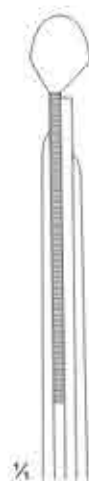

03-238
LISTER
Nurse's scissors
Size: 145 mm

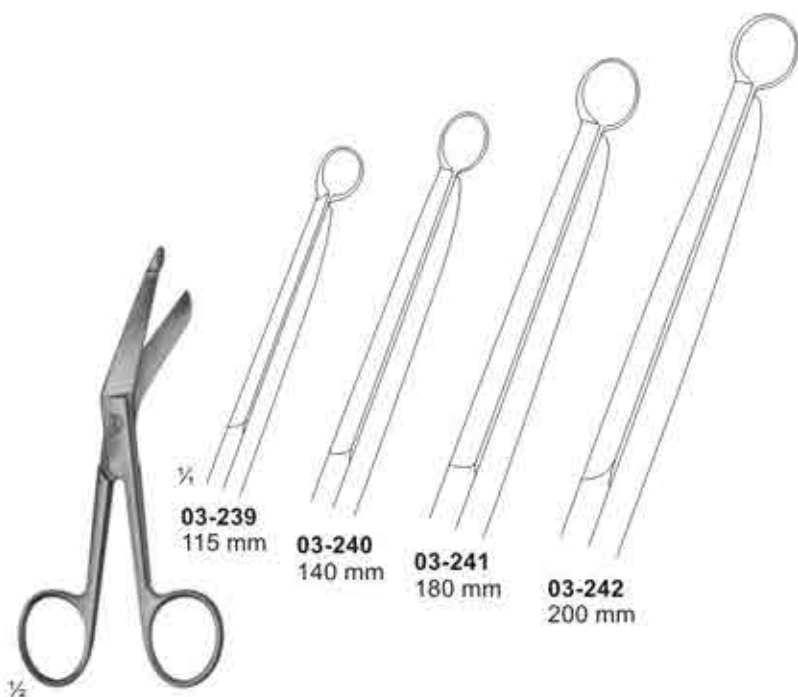

03-239 - 03-242
LISTER

03-239
115 mm

03-240
140 mm

03-241
180 mm

03-242
200 mm



03-243 - 03-244
LISTER

03-243
155 mm

03-244
180 mm

Bandage-, Cloth-, and Plaster Scissors



03-245
CLOTH SCISSORS
205 mm

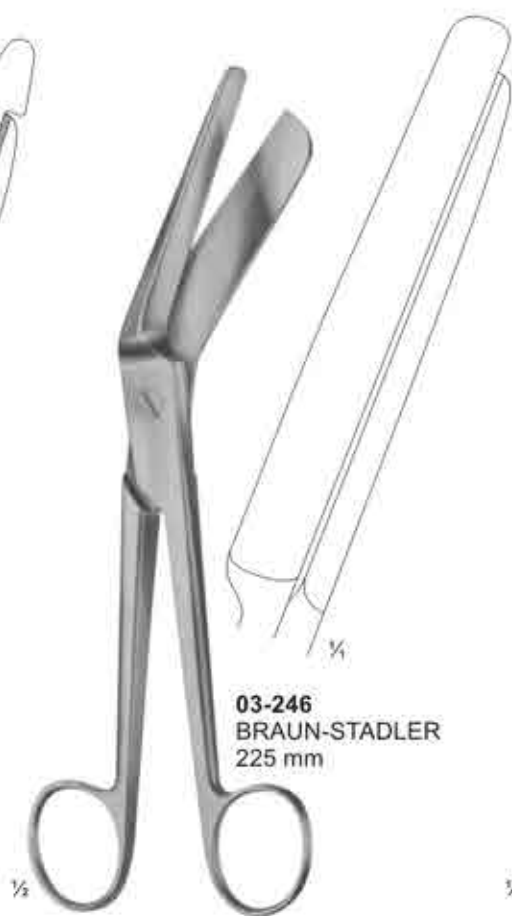

03-246
BRAUN-STADLER
225 mm



03-247
SEUTIN
230 mm



03-248 **03-249**
200 mm 230 mm

03-248 - 03-249
ESMARCH



03-250
BRUNS
235 mm



03-251
Bandage Scissors
235 mm

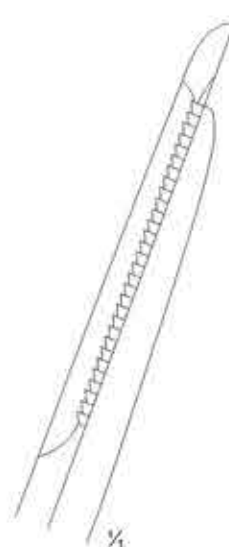

Forceps for grasping tissue, tumors etc.

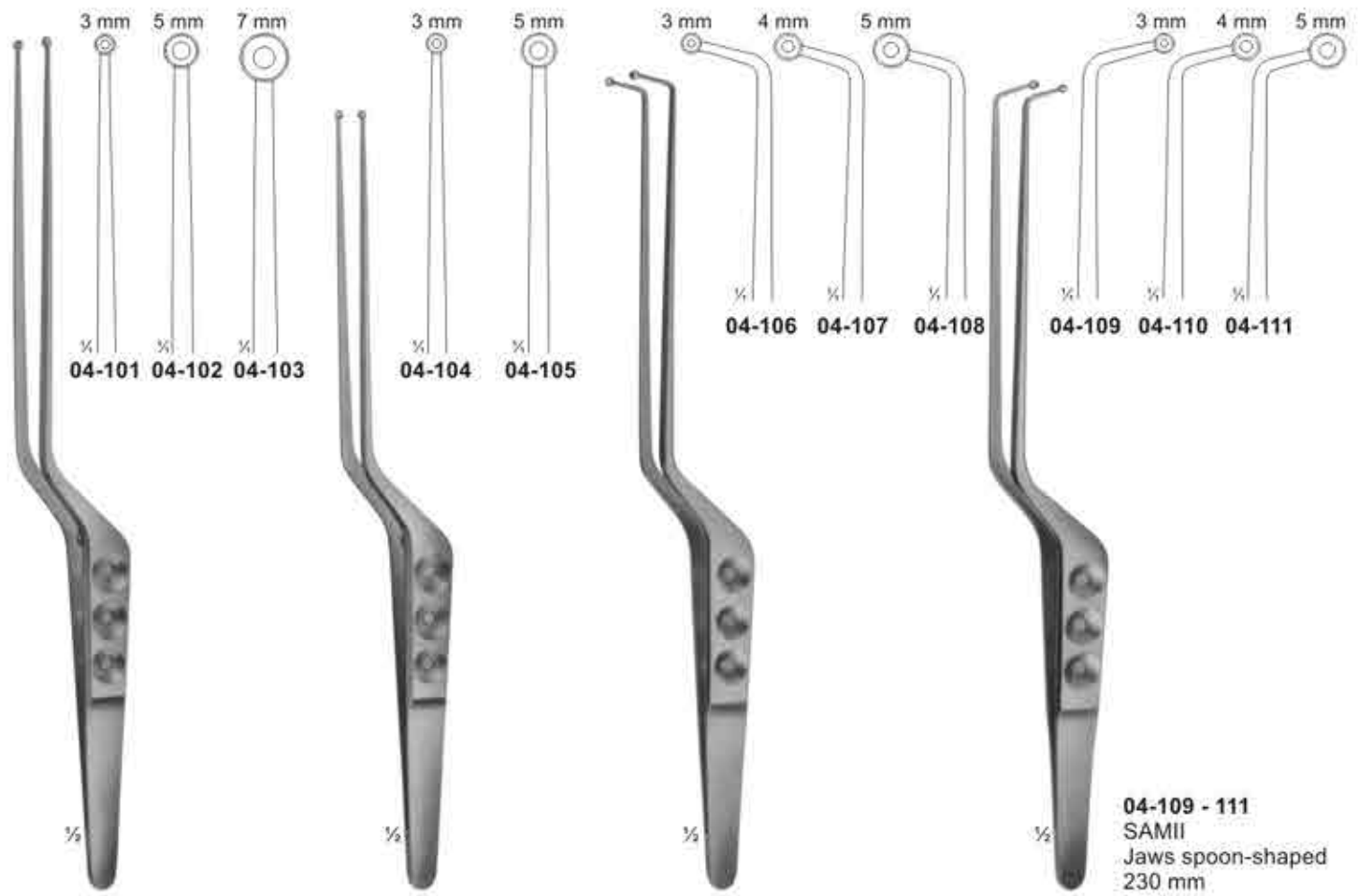

04-101 - 103
YASARGIL-SAMII
Jaws spoon-shaped
240 mm

04-104 - 105
YASARGIL
Jaws spoon-shaped
220 mm

04-106 - 108
SAMII
Jaws spoon-shaped
230 mm

04-109 - 111
SAMII
Jaws spoon-shaped
230 mm



04-112
HUNT
Tumor-and
vessel forceps
200 mm



04-113
HUNT
Tumor-and
vessel forceps
200 mm



04-114
YASARGIL
Tumor-and
vessel forceps
200 mm

Delicate Dissecting, Microscopic, Sterilizing Forceps

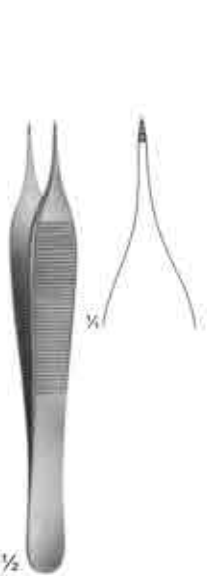

04-115
THORPE
 Corneal forceps
 120 mm

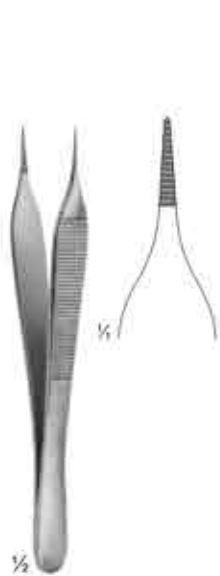

04-116
MICRO-ADSON
 120 mm

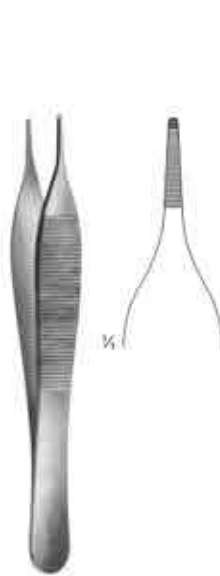

04-117
ADSON
 120 mm



04-118
MICRO-ADSON
 150 mm

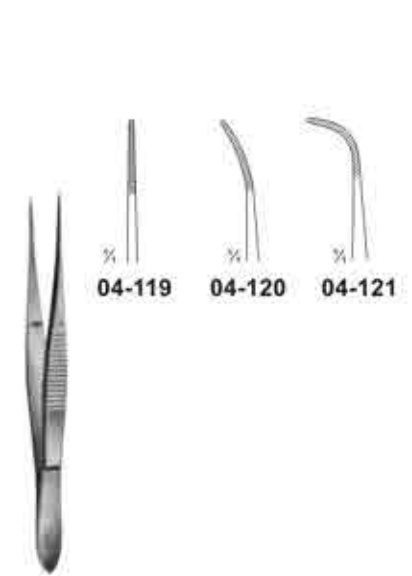

04-119 - 121
 100 mm



04-122
BONACCOLTO
 110 mm



04-123
 115 mm

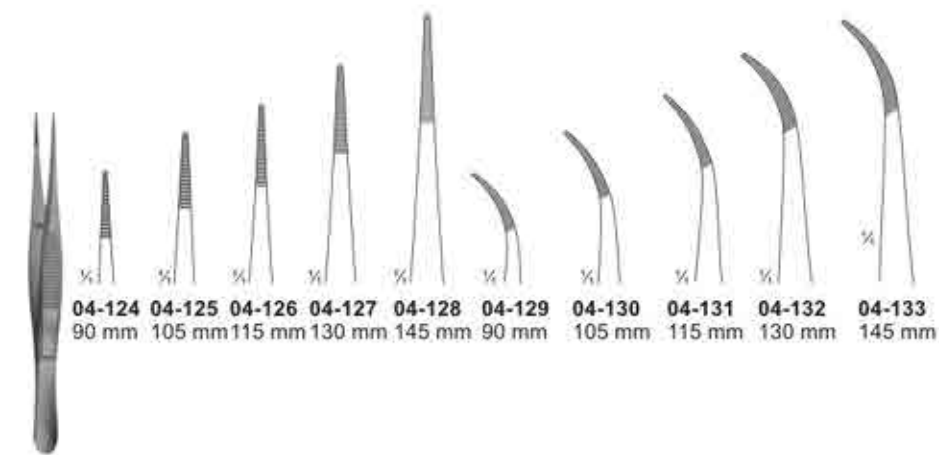

04-124 - 133

04-124 90 mm **04-125** 105 mm **04-126** 115 mm **04-127** 130 mm **04-128** 145 mm **04-129** 90 mm **04-130** 105 mm **04-131** 115 mm **04-132** 130 mm **04-133** 145 mm



04-134
 100 mm



04-135
 100 mm



04-136
 100 mm

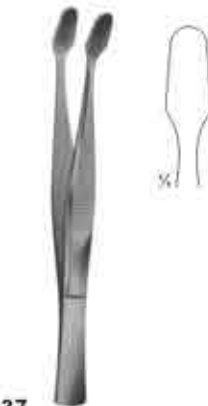

04-137
KUHNE
 Cover glass forceps, 105 mm



04-138
 160 mm

Delicate Dissecting Forceps

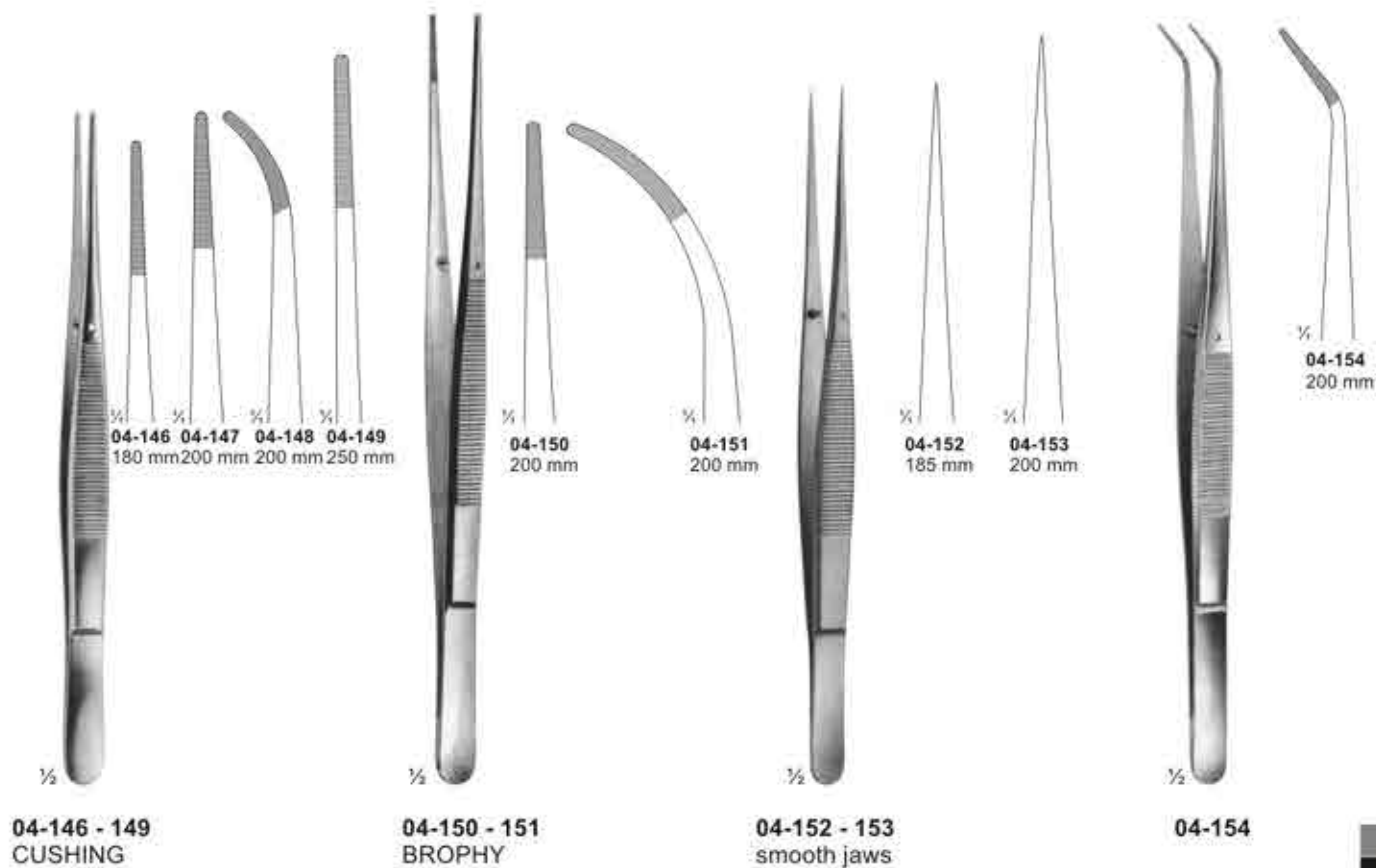
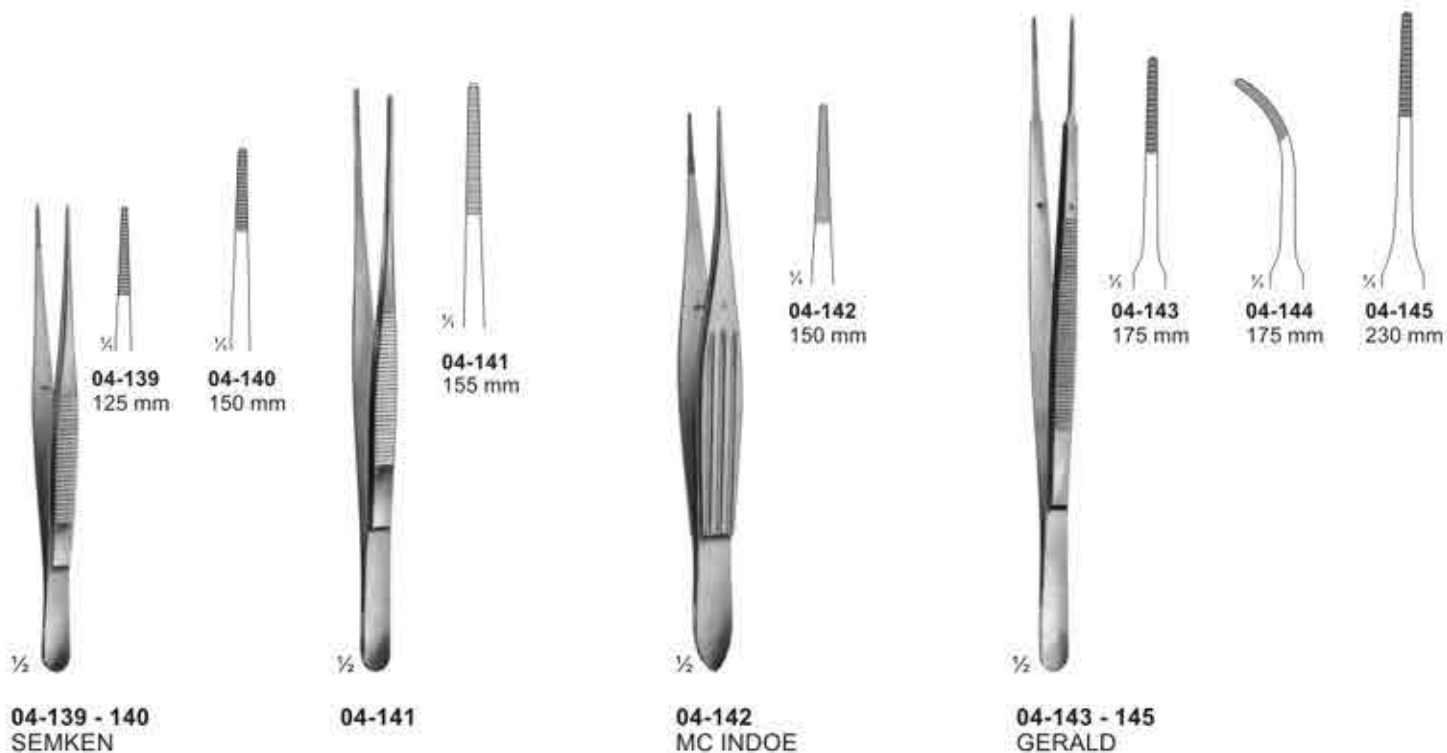

Dissecting Forceps

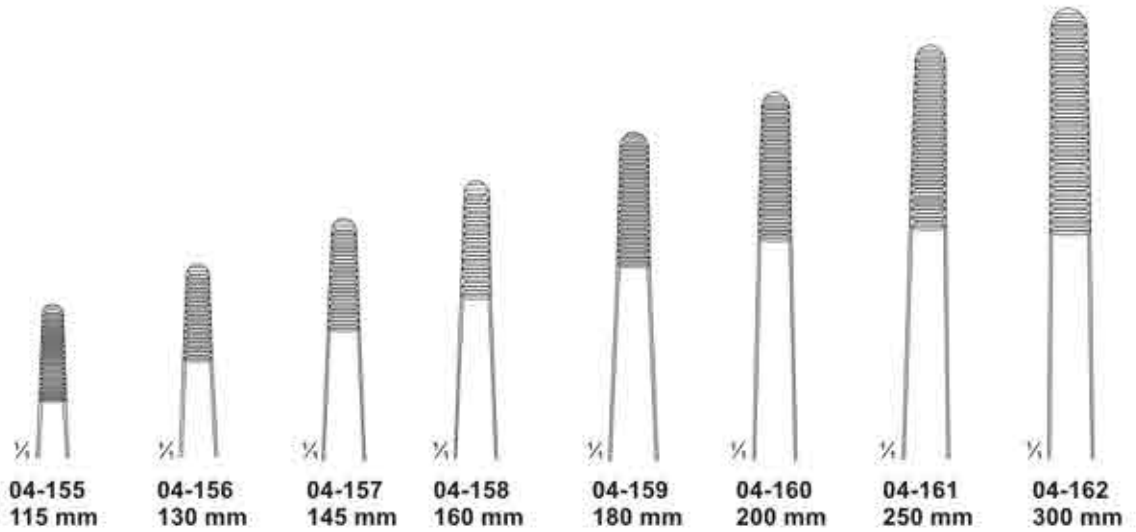

04-155 - 04-162
STANDARD

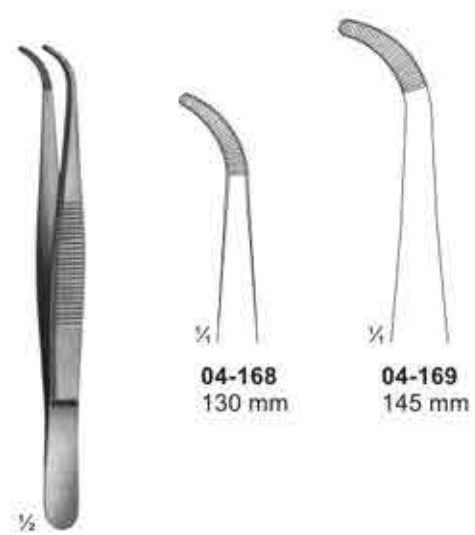
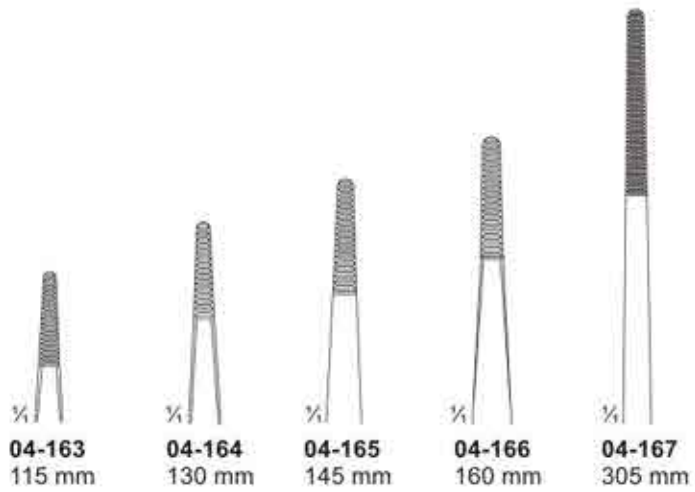

04-163 - 04-167
MEDIUM

04-168 - 04-169
MEDIUM

Forceps

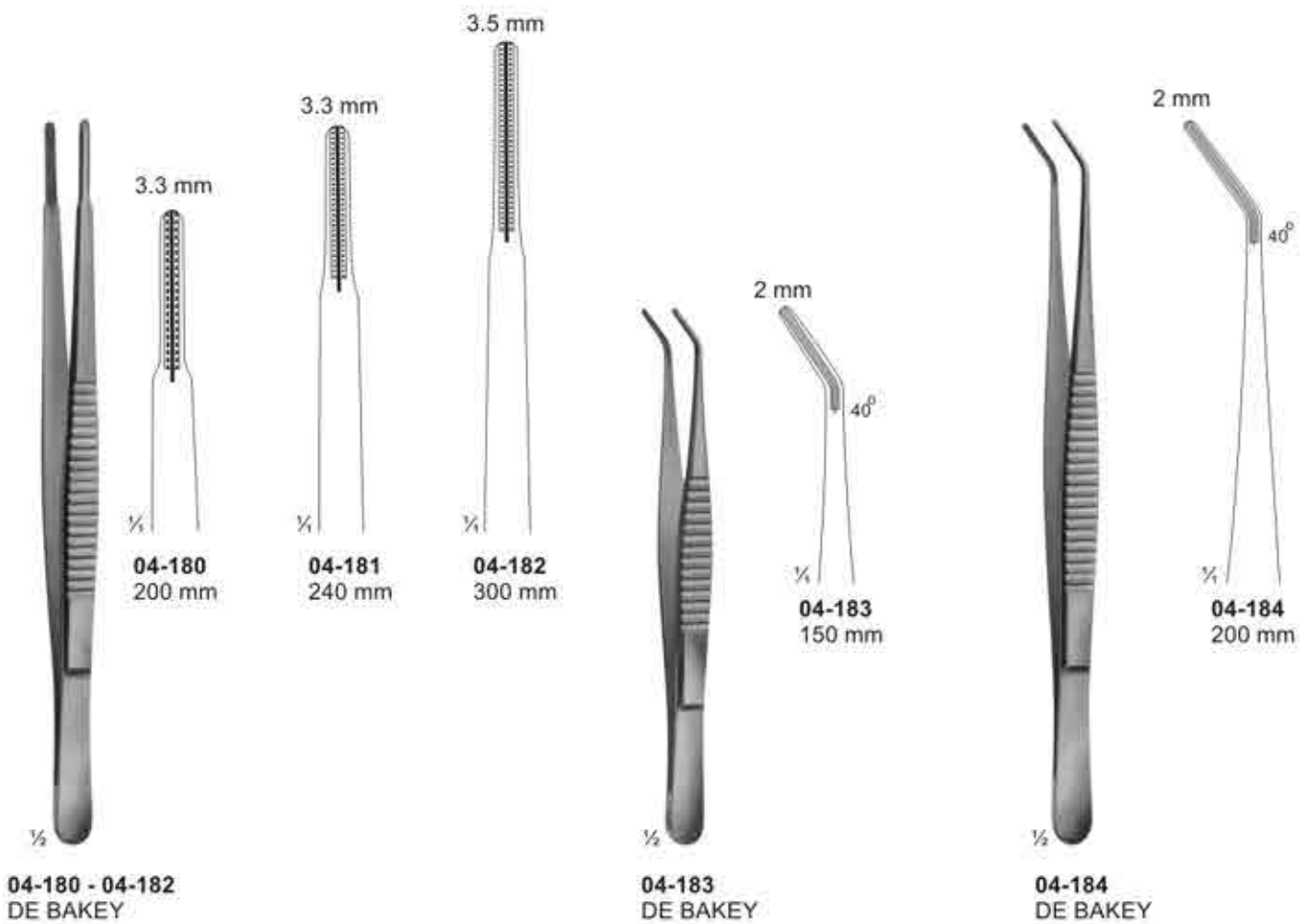
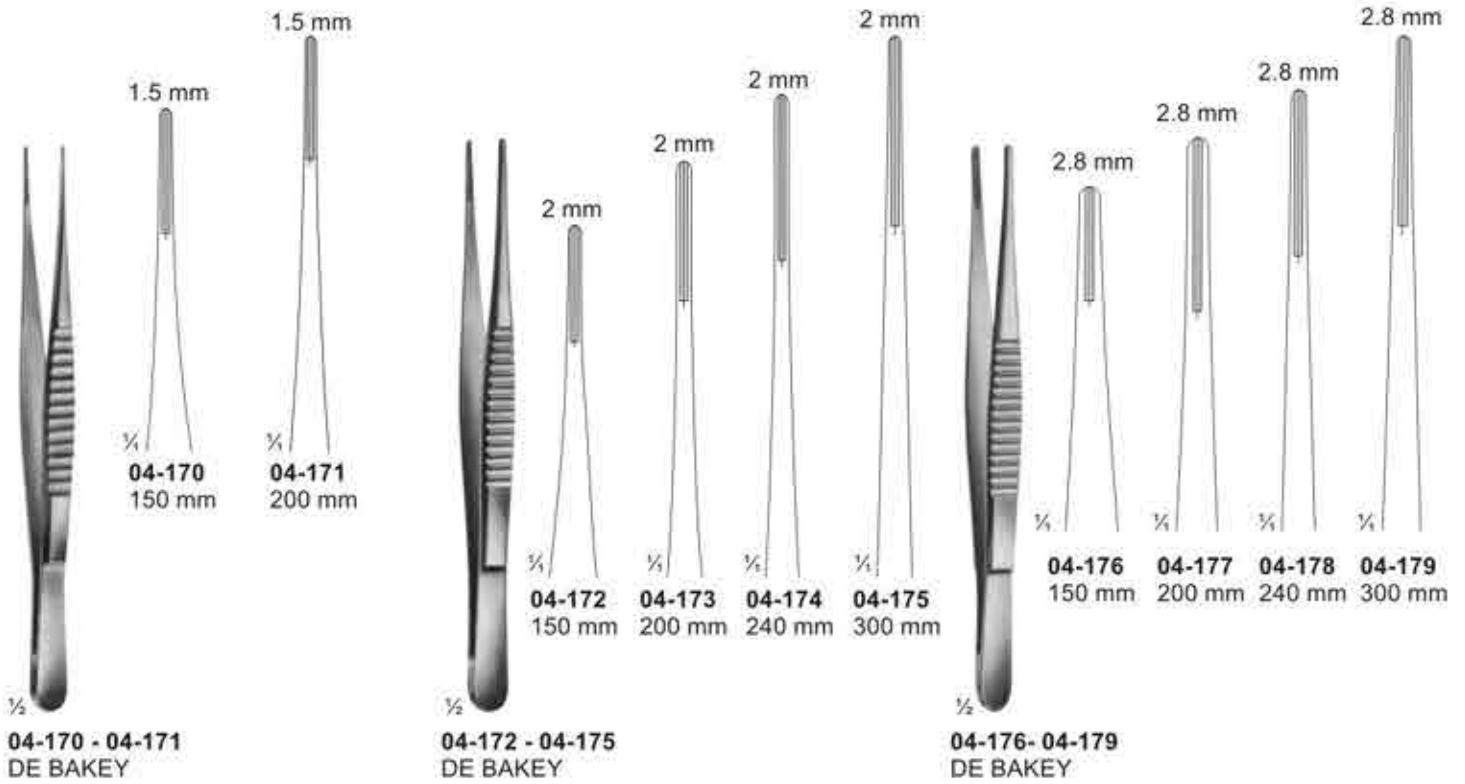

Delicate Tissue Forceps



04-185
BISHOP-HARMON
85 mm

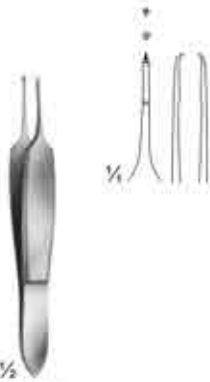

04-186
ST.MARTIN
80 mm



04-187
CASTROVIEJO
teeth 0.9 mm
100 mm

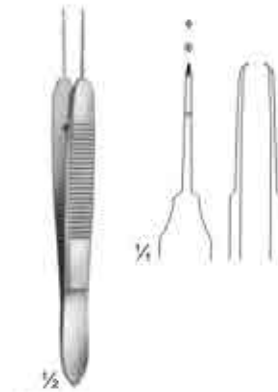

04-188
CASTROVIEJO
teeth 0.5 mm
100 mm



04-189
ELSCHING
110 mm



04-190
GILL
75 mm



04-191
GILL - HESS
75 mm

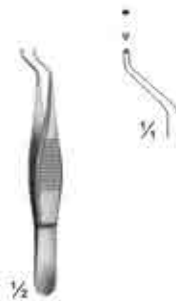

04-192
HESS
70 mm



04-193
ARRUGA
100 mm



04-194
SEMKEN
125 mm 125 mm 150 mm
2 X 3 teeth



04-195
MICRO-ADSON
120 mm

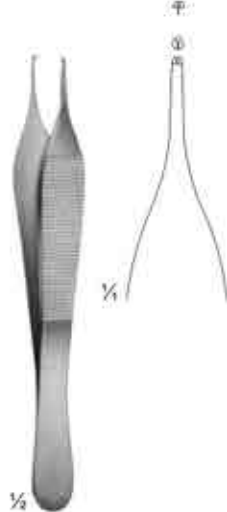

04-196
ADSON
120 mm



04-197
ADSON
120 mm



04-198
ADSON
120 mm



04-199
ADSON
150 mm

Tissue Forceps

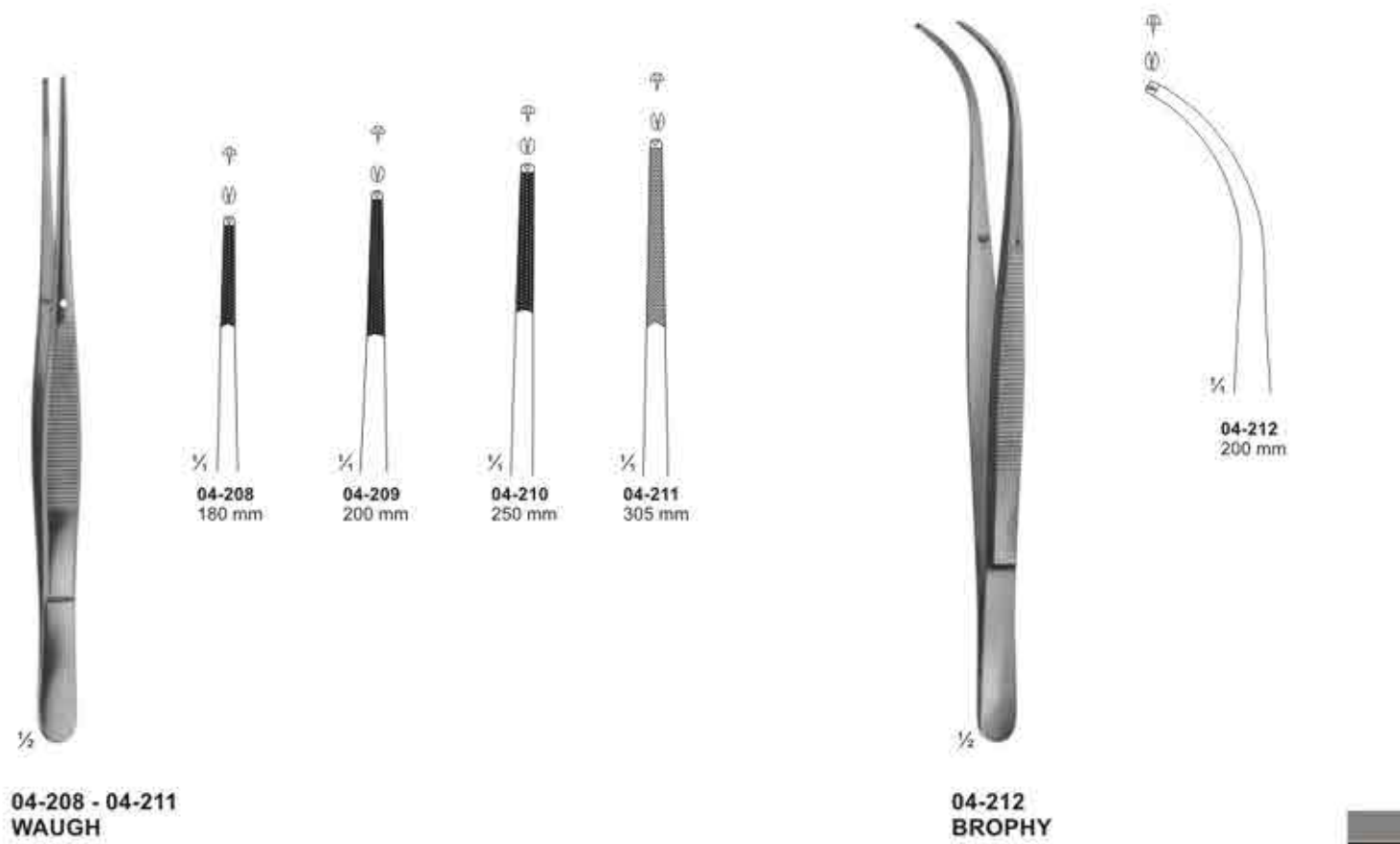
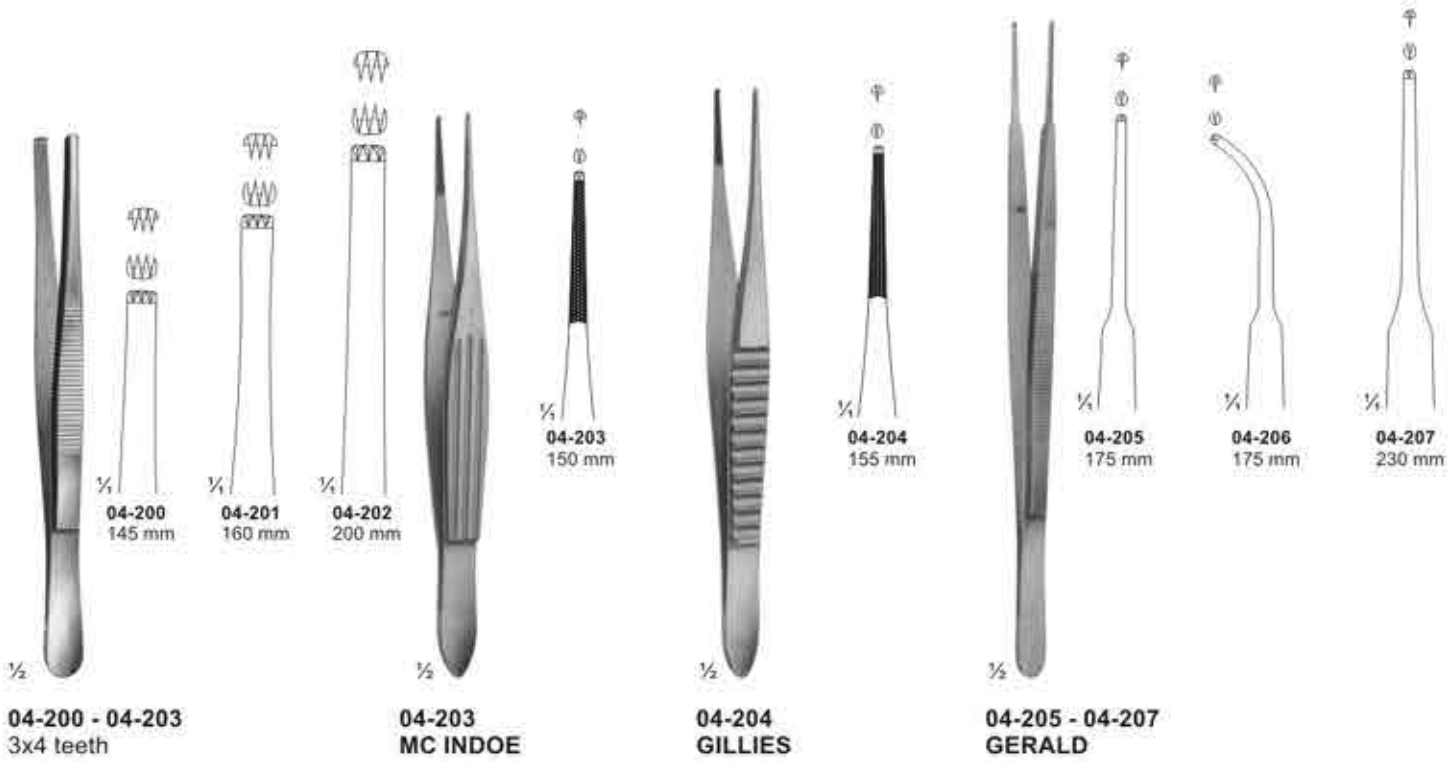

Tissue Forceps



04-213
ADSON - BROWN
 Non-traumatic
 120 mm



04-214
BROWN
 120 mm



04-215
GRAEFE
 110 mm



04-216
GRAEFE
 With Catch
 110 mm

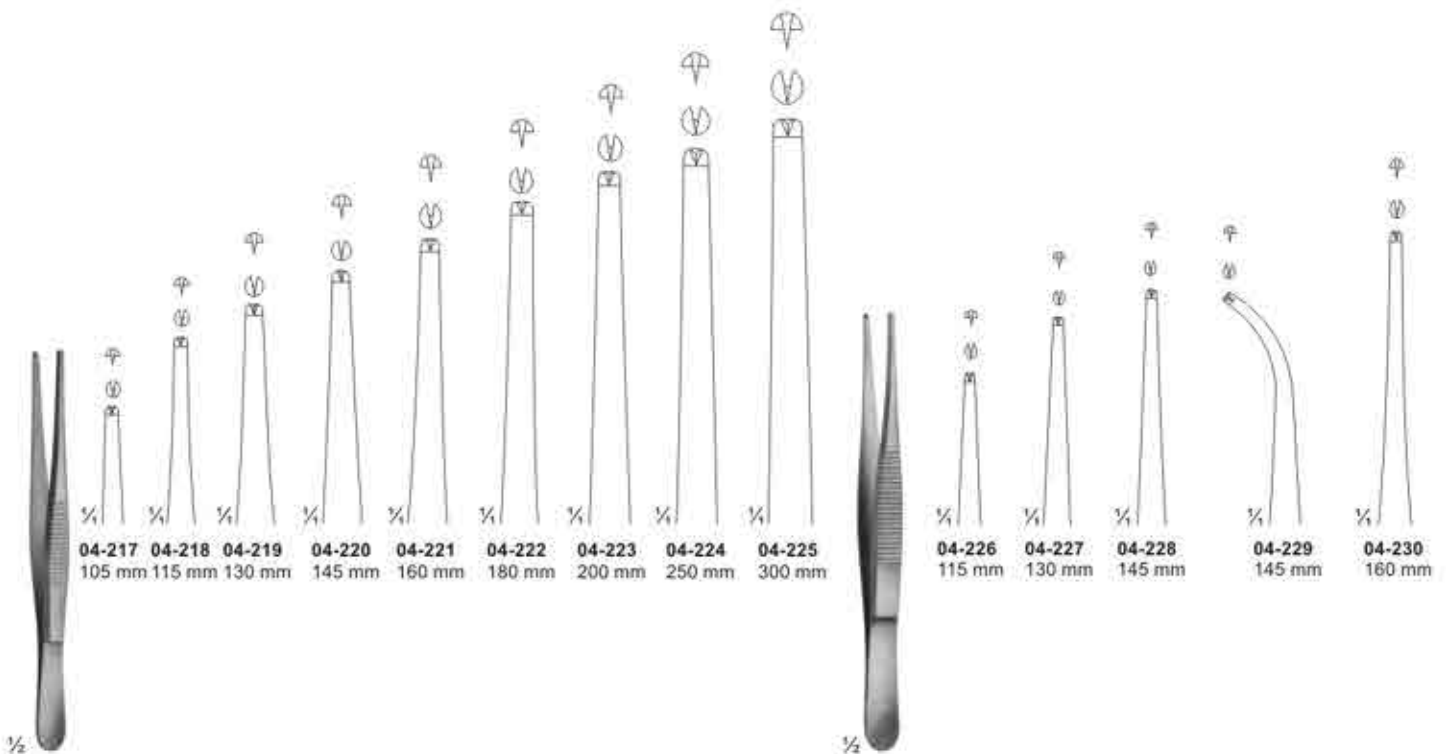

04-217 - 04-225
STANDARD

04-226 - 04-230
GRAEFE
 110 mm

Forceps, Bayonet - Shaped



04-231
LUCAE
140 mm



04-232
LUCAE
1x2 teeth
140 mm



04-233
COTTLE
Forceps with
jaws toothed
and serrated
140 mm



04-234
JANSEN
160 mm



04-235
GRUENWALD
200 mm



04-236
1x2 teeth
200 mm



04-237
TROELTSCH
100 mm



04-238
TROELTSCH
115 mm



04-239
TROELTSCH
1X2 teeth
115 mm



04-240
WILDE
115 mm

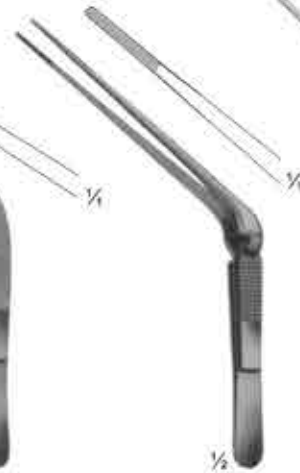

04-241
TROELTSCH
Cross action
120 mm



04-242
TROELTSCH
140 mm

Tissue Forceps, Lung Dissecting Forceps

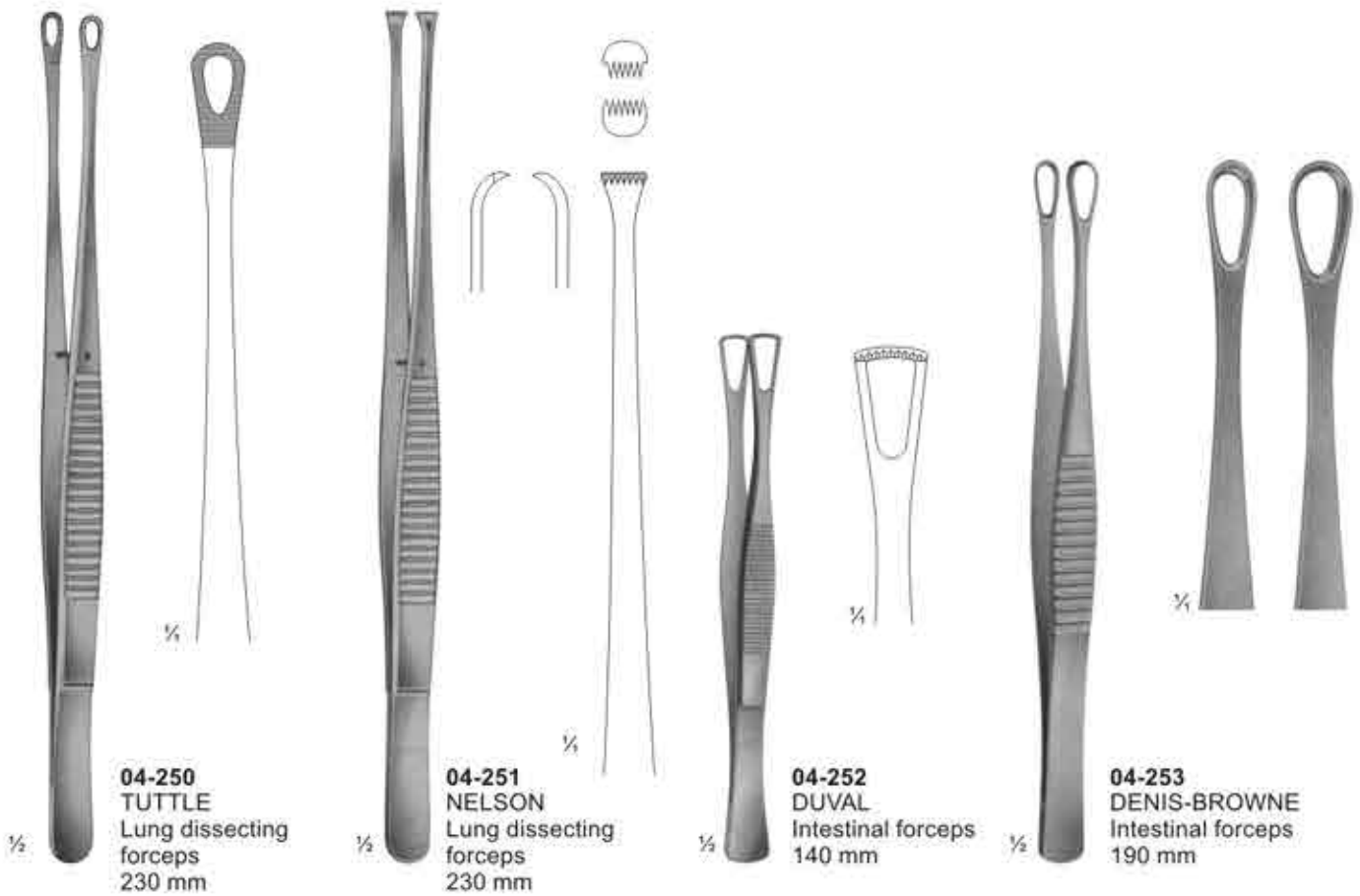
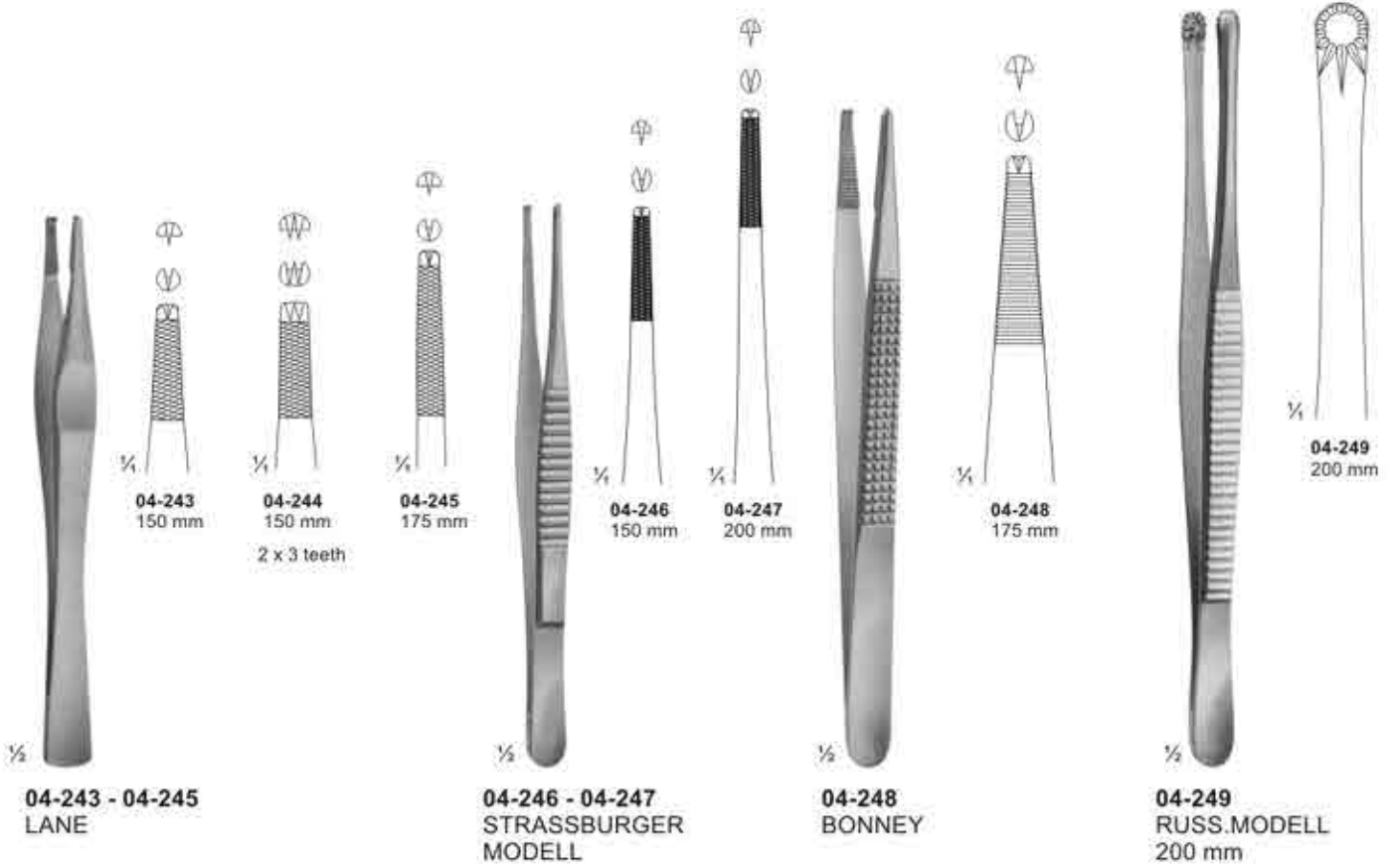

Splinter and Cilia Forceps

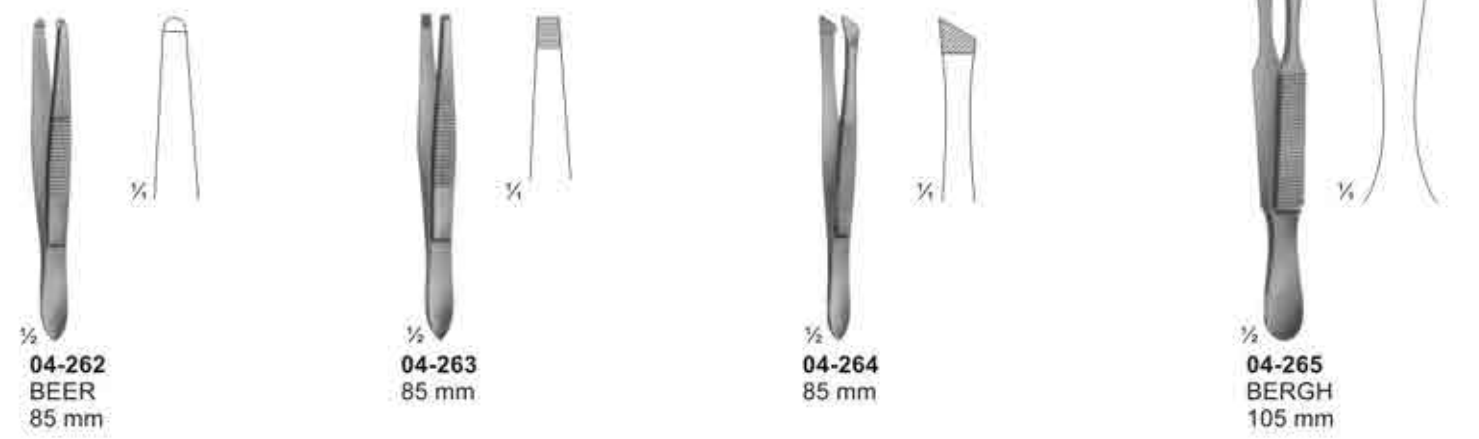
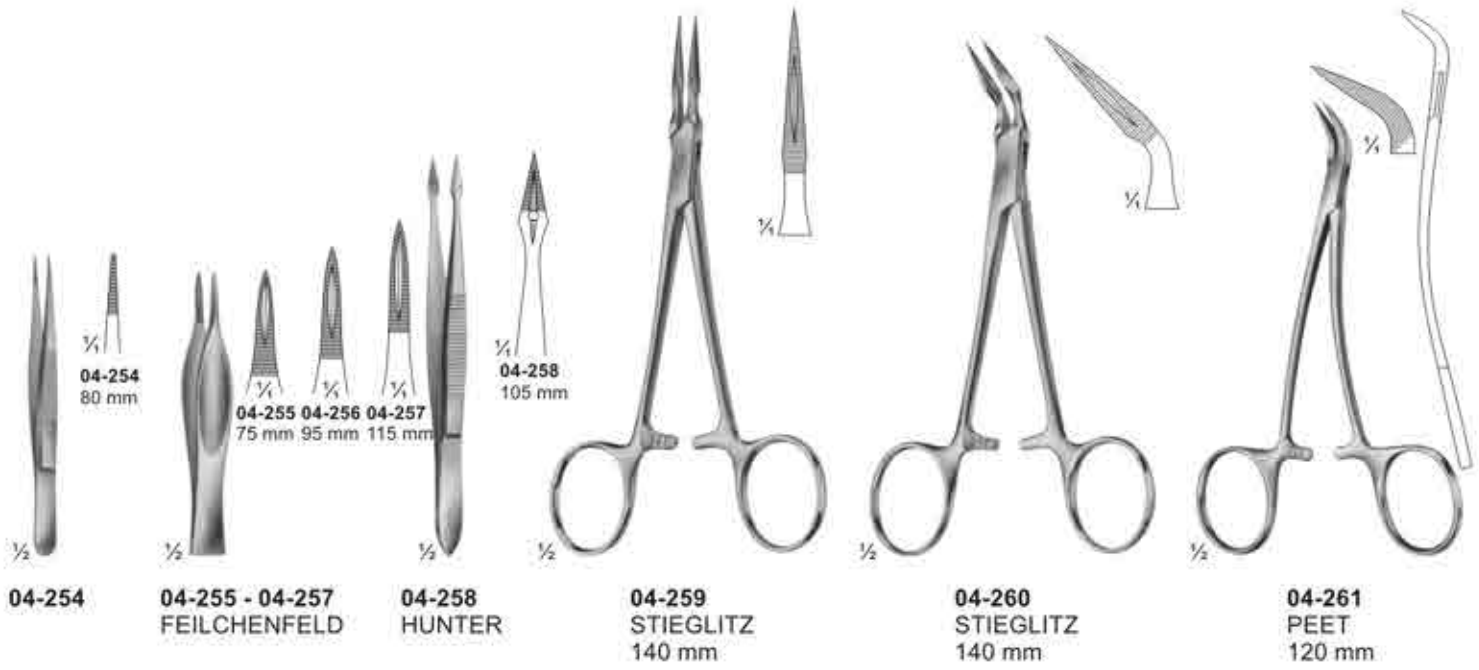

Sponge and Dressing Forceps



04-270
BRYANT
130 mm

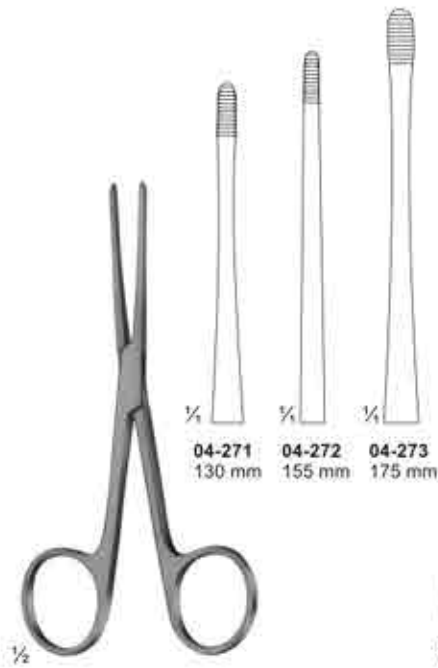

04-271 - 04-273
LISTER
Sinus forceps

04-271 130 mm
04-272 155 mm
04-273 175 mm

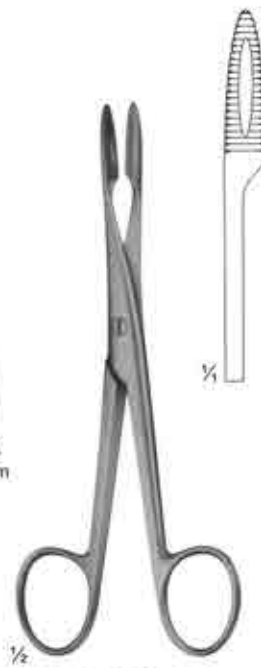

04-274
without ratchet
145 mm

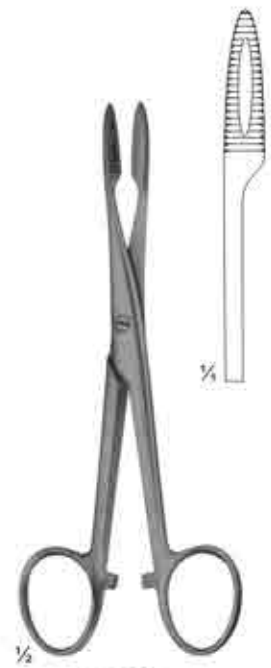

04-275
with ratchet
145 mm

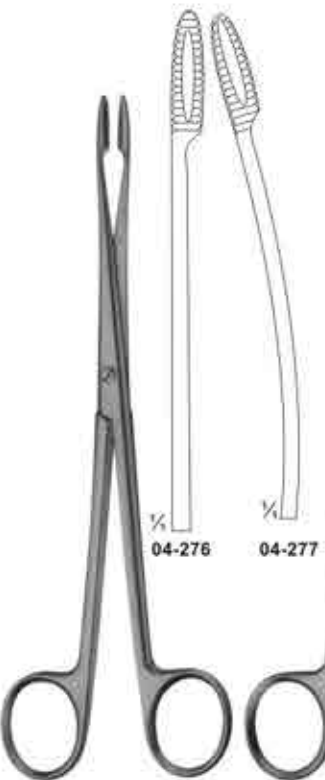

04-276 - 04-277
GROSS
without ratchet
180 mm

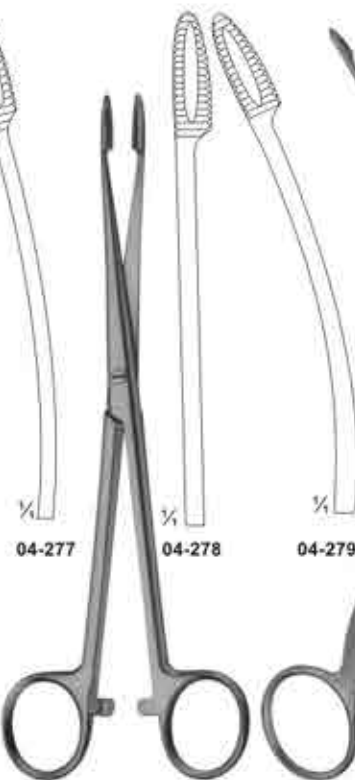

04-278 - 04-279
GROSS
with ratchet
180 mm

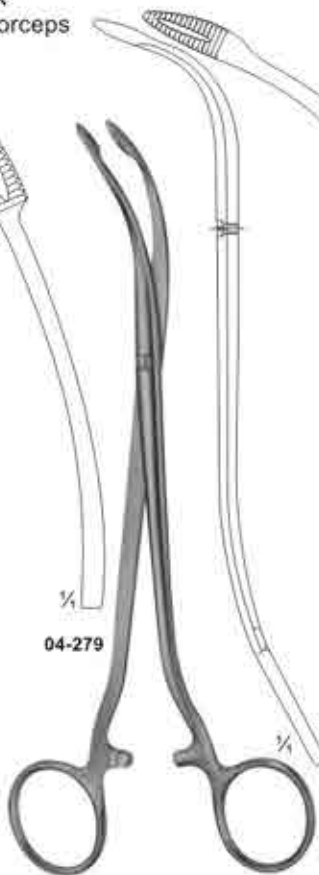

04-280
DUPLAY
190 mm

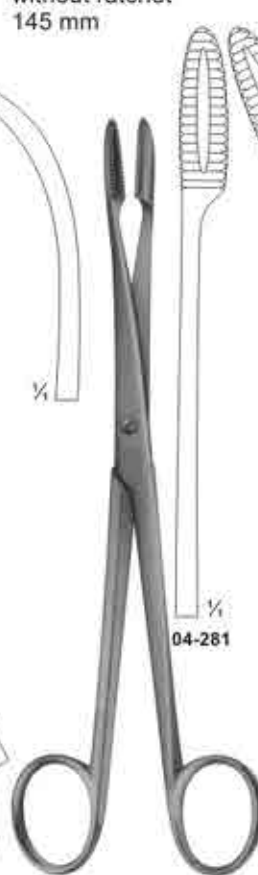

04-281 - 04-282
GROSS
without ratchet
200 mm

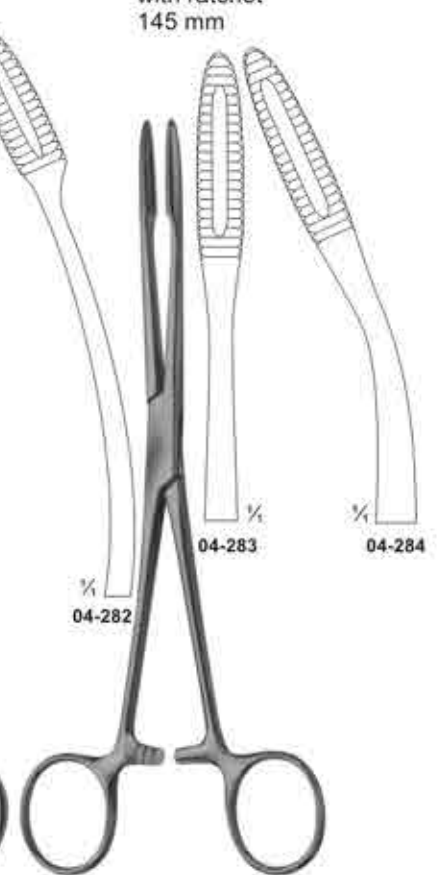

04-283 - 04-284
GROSS
200 mm

Dressing-, Sponge holding-, Organ- and Tissue Grasping Forceps

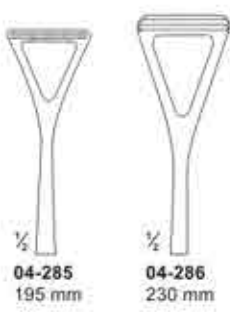

04-285
195 mm

04-286
230 mm

04-285 - 04-286
COLLIN

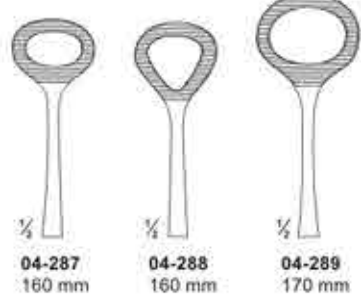

04-287
160 mm

04-288
160 mm

04-289
170 mm

04-287 - 04-289
COLLIN

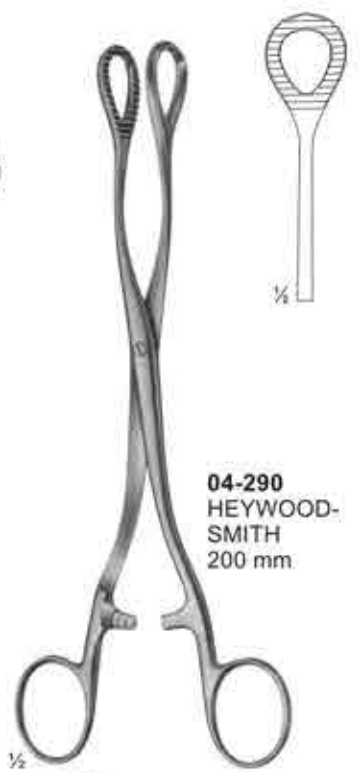

04-290
HEYWOOD-SMITH
200 mm



04-291
NOTO
280 mm

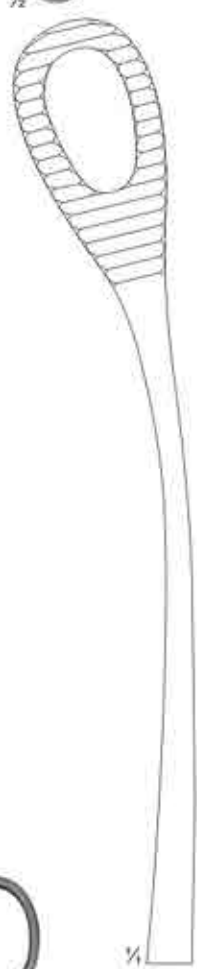

04-292
KELLY
320 mm

Dressing, Sponge holding, Organ and Tissue Grasping Forceps

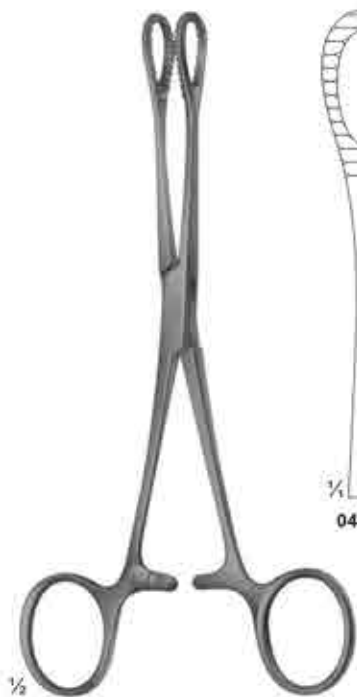

04-293



04-294

04-293 - 04-294
FOERSTER-BALLENGER
180 mm



04-295
180 mm



04-296
250 mm

04-295 - 04-296
RAMPLEY



04-297
Smooth Jaws

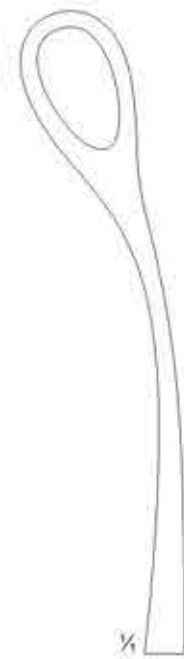

04-298
Smooth Jaws

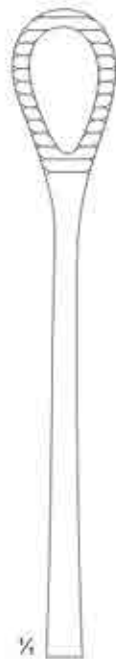

04-299
Serrated Jaws

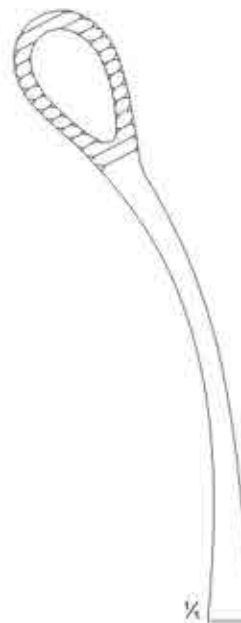

04-300
Serrated Jaws

04-297 - 04-300
FOERSTER-BALLENGER
240 mm

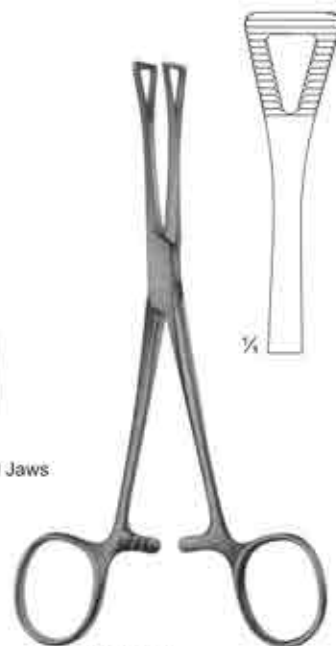

04-301

04-301
PENNINGTON
155 mm

Intestinal Grasping Forceps

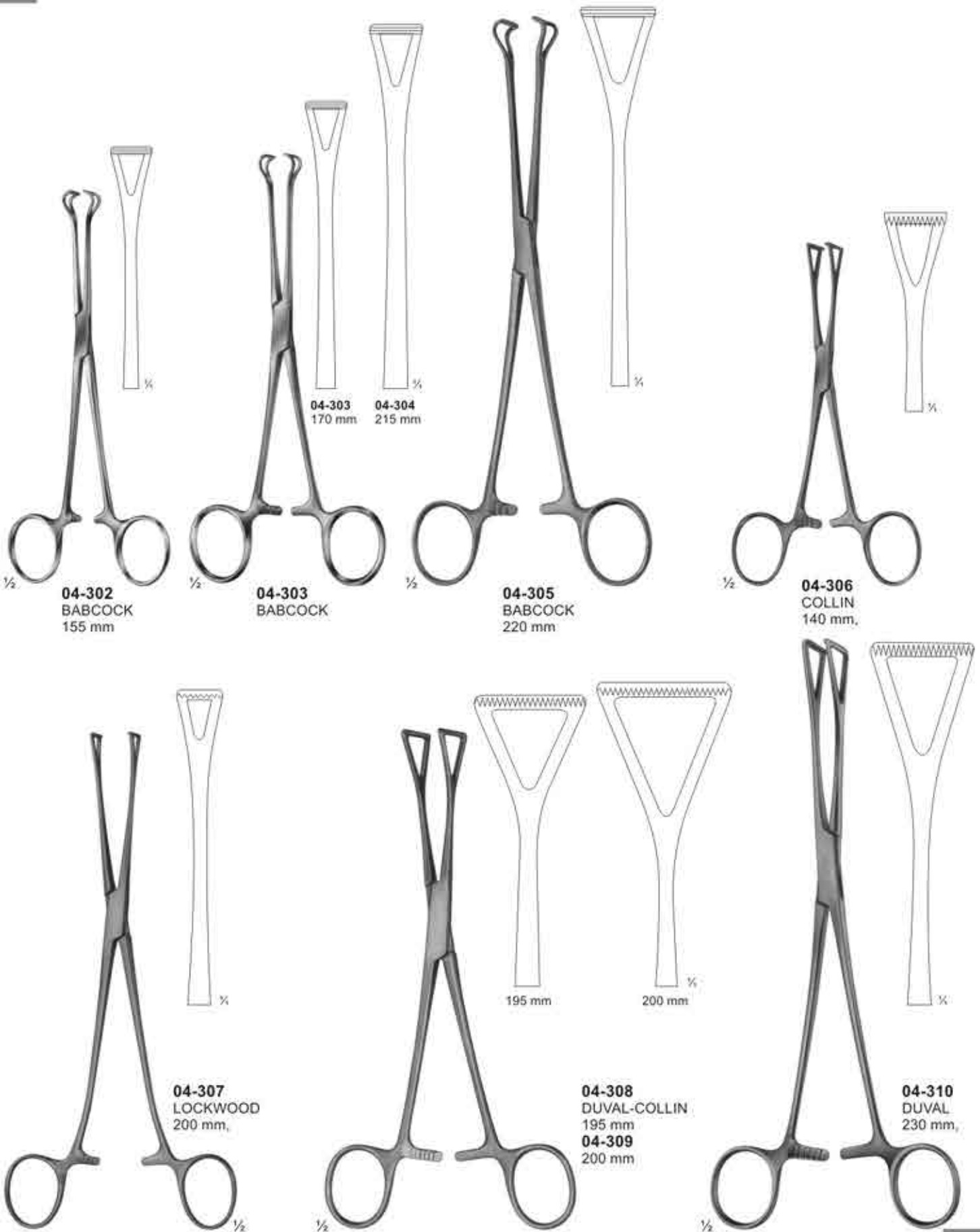

Artery Traction - and Tissue Grasping Forceps



04-311
CHAPUT
 2 x 3 teeth
 125 mm

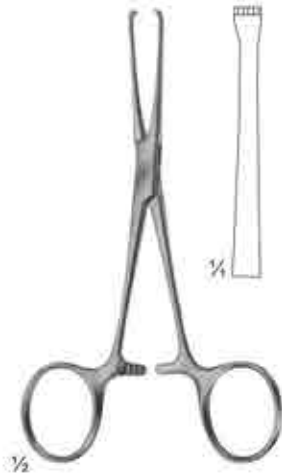

04-312
BABY-ALLIS
 4 x 5 teeth
 130 mm



04-313
BOYS-ALLIS
 5 x 6 teeth sharp
 155 mm

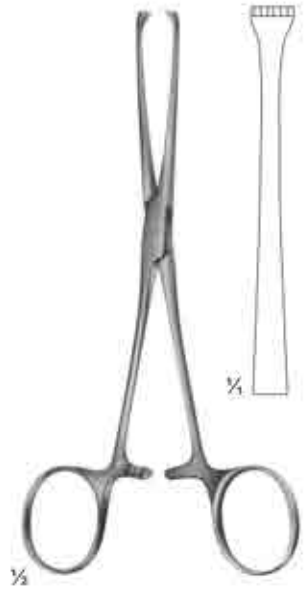

04-314
ALLIS
 5 x 6 teeth
 155 mm



04-315
LAHEY
 155 mm

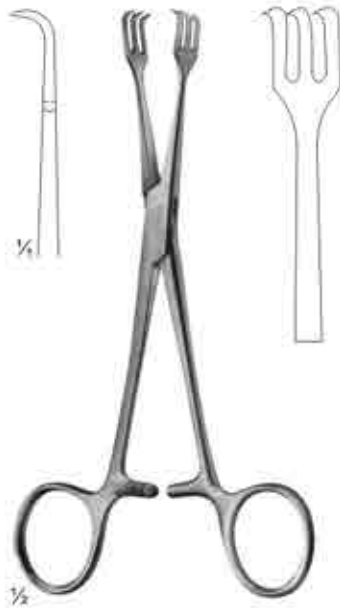

04-316
LAHEY
 155 mm

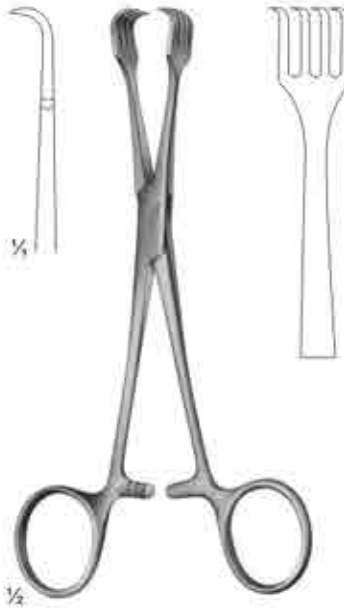

04-317
BRAUN
 155 mm

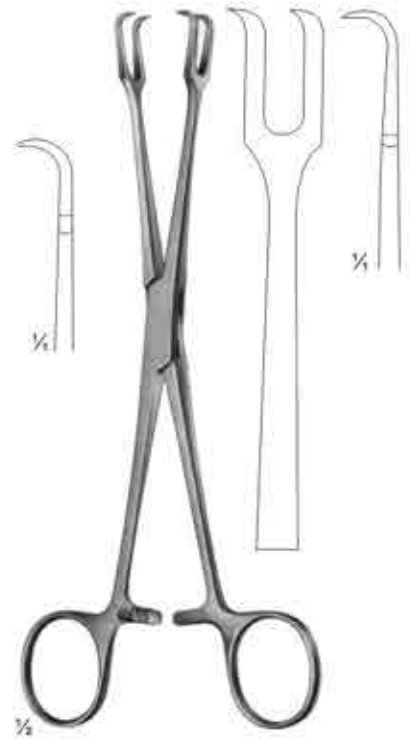

04-318
MUSEUX
 200 mm

Towel Clamps

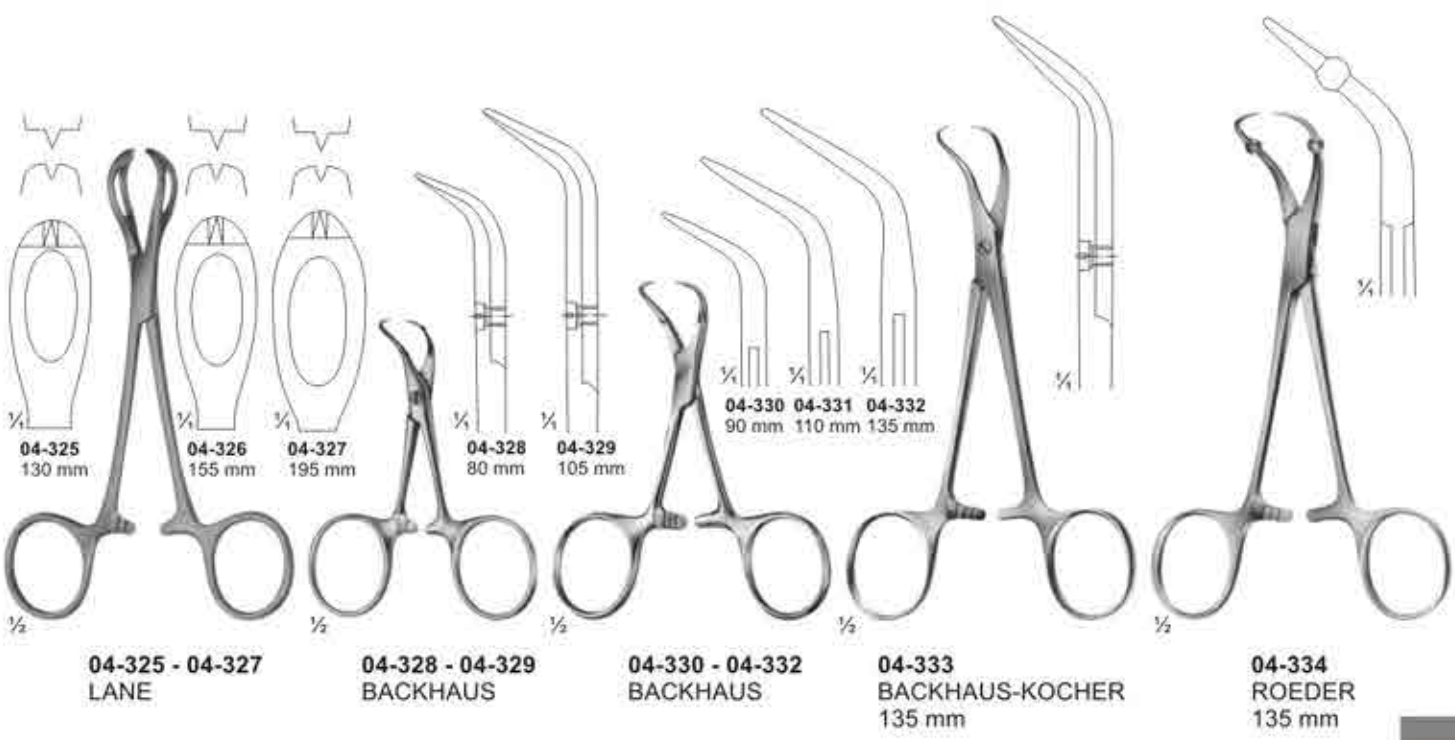

Muller Vessel Clips and Bulldog Clamps

Closing force

04-335 straight 80g 50g
04-336 curved 80g 50g
04-337 curved tips 80g 50g
04-338 angled shaped 80g 50g
04-339 MULLER knee-bent 80g 50g
04-340 Muller Ligature Forceps

04-341 35 mm
04-342 35 mm
04-343 45 mm
04-344 45 mm
04-345 DIEFFENBACH 38 mm
04-346 DIEFFENBACH 48 mm
04-347 DIEFFENBACH 38 mm
04-348 DIEFFENBACH 48 mm
04-349 DIEFFENBACH 58 mm
04-350 DIEFFENBACH 58 mm
04-351 - 04-357 JOHNS-HOPKINS 91 mm
04-358 DE BAKEY-HESS 20 mm

04-359 DE BAKEY length 50 mm jaws 27 mm
04-360 DE BAKEY length 48 mm jaws 27 mm
04-361 GLOVER length 57 mm jaws 35 mm
04-362 DE BAKEY length 73 mm jaws 38 mm
04-363 DE BAKEY length 99 mm jaws 63 mm
04-364 DE BAKEY length 95 mm jaws 54 mm
04-365 DE BAKEY L. 80 mm
04-366 DE BAKEY L. 90 mm
04-367 DE BAKEY L. 105 mm
04-368 DE BAKEY L. 124 mm
04-369 DE BAKEY L. 78 mm
04-370 DE BAKEY L. 86 mm
04-371 DE BAKEY L. 97 mm
04-372 DE BAKEY L. 114 mm
04-373 GLOVER L. 68 mm
04-374 GLOVER L. 96 mm
04-375 GLOVER L. 117 mm
04-376 GLOVER L. 65 mm
04-377 GLOVER L. 91 mm
04-378 GLOVER L. 110 mm

Jaw, cross serrated

Delicate Haemostatic Forceps

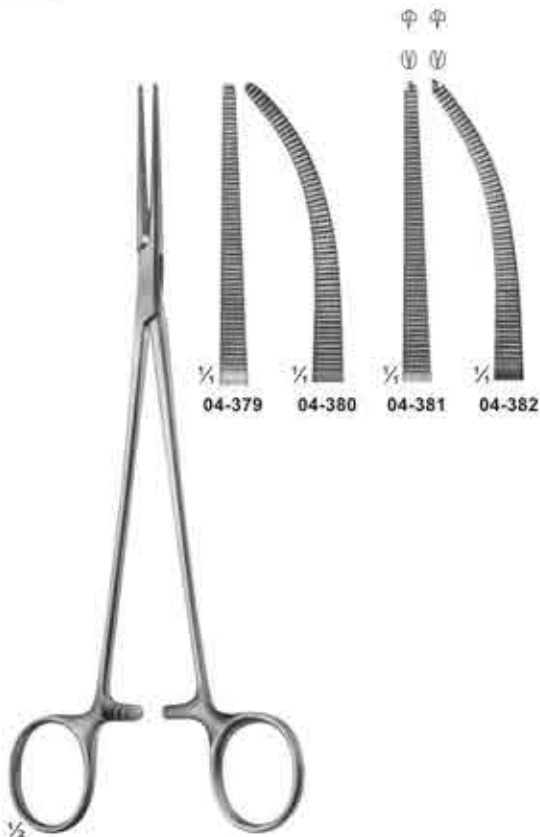

04-379 - 04-382
HALSTED-MOSQUITO
200 mm



04-383 - 04-387
HEISS
200 mm



04-388 - 04-389
HALSTED
215 mm

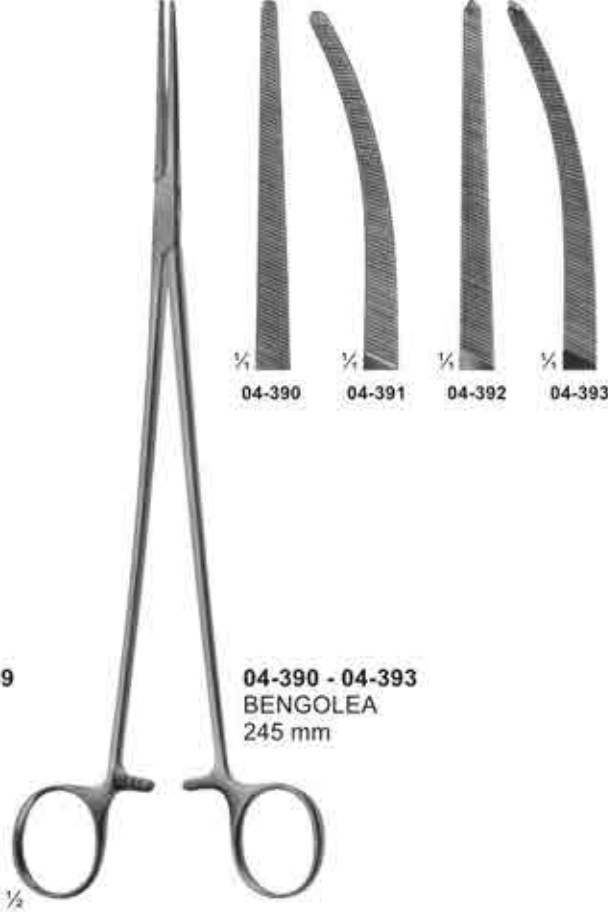

04-390 - 04-393
BENGOLEA
245 mm



04-394
CRAFOORD
245 mm

Delicate Haemostatic Forceps



04-395
CARREL
85 mm



04-396 - 04-399
BABY-MOSQUITO
(HARTMANN)
100 mm



04-400 - 04-403
MICRO-HALSTED
125 mm

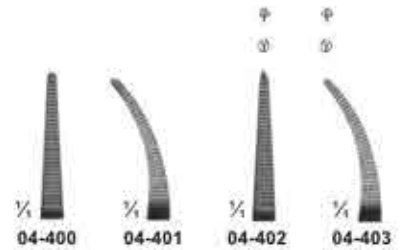

04-404 - 04-407
HALSTED-MOSQUITO
125 mm

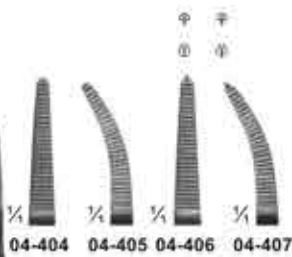

04-408 - 04-409
PROVIDENCE-HOSPITAL
140 mm

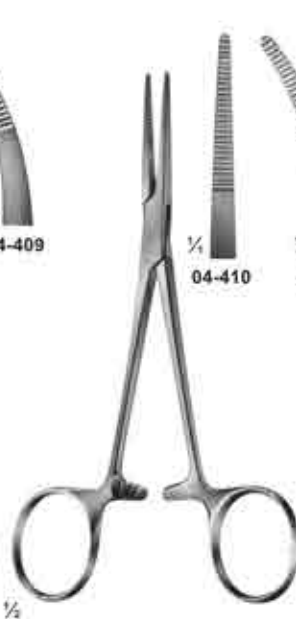

04-410 - 04-411
KELLY
140 mm

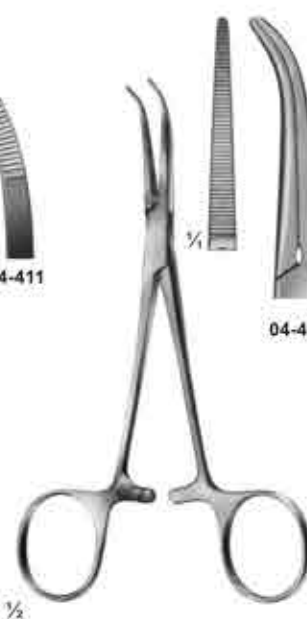

04-412 - 04-413
DANDY
Curved sideways
140 mm

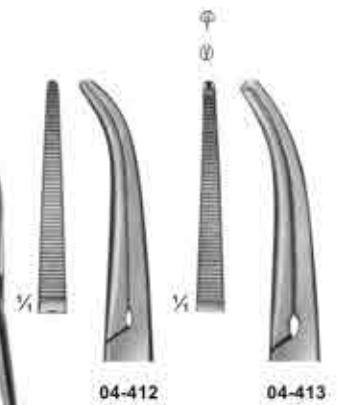

Delicate Haemostatic Forceps

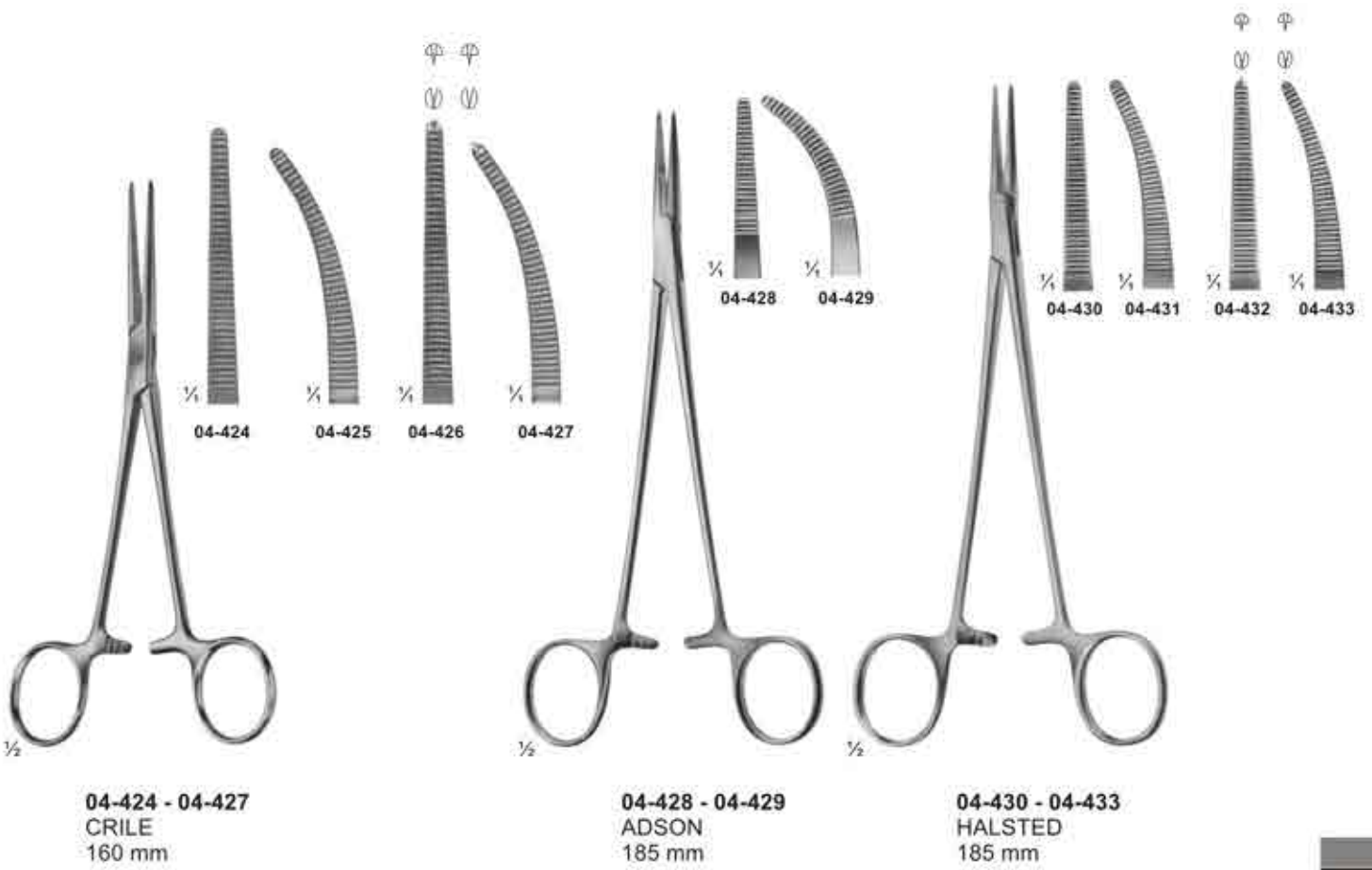
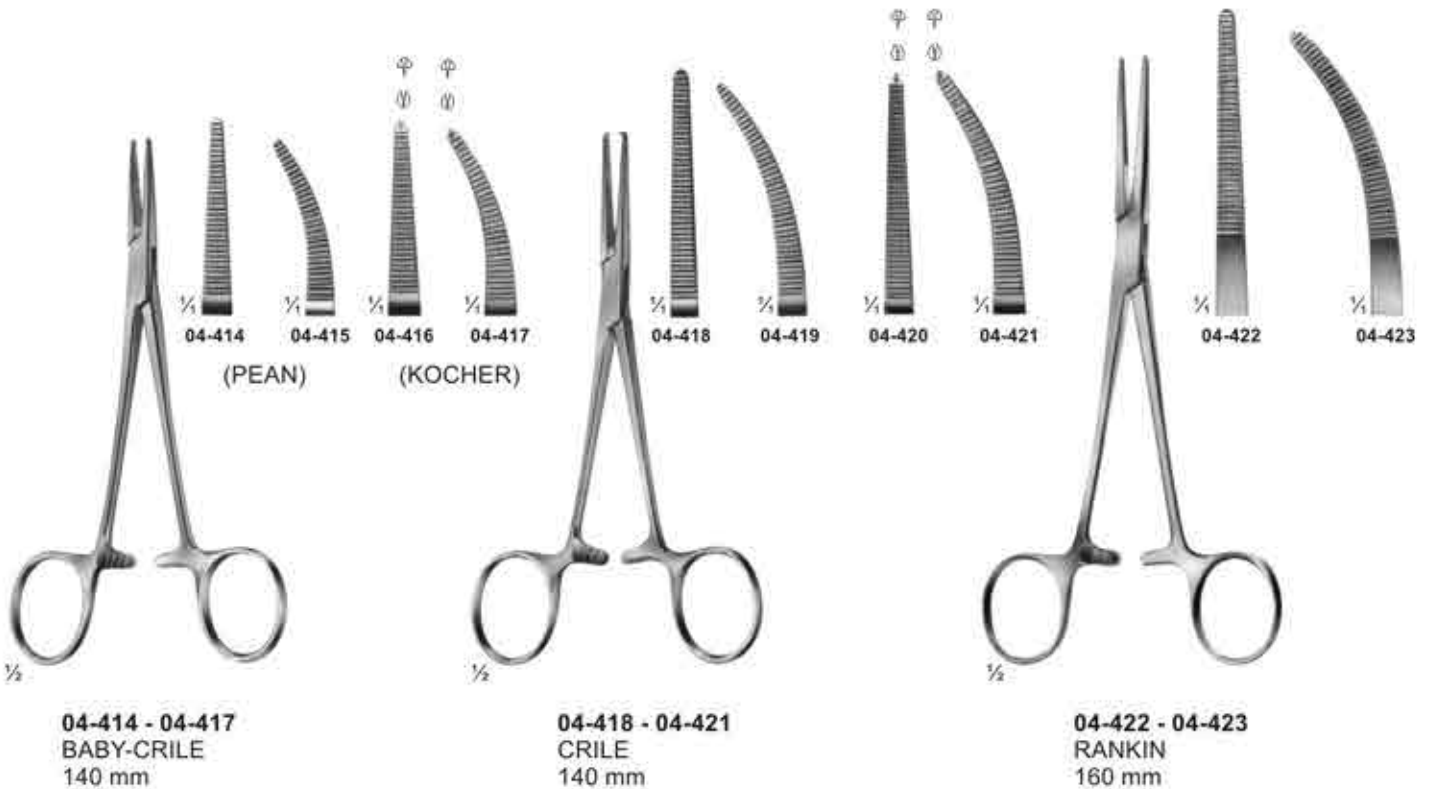

Haemostatic Forceps

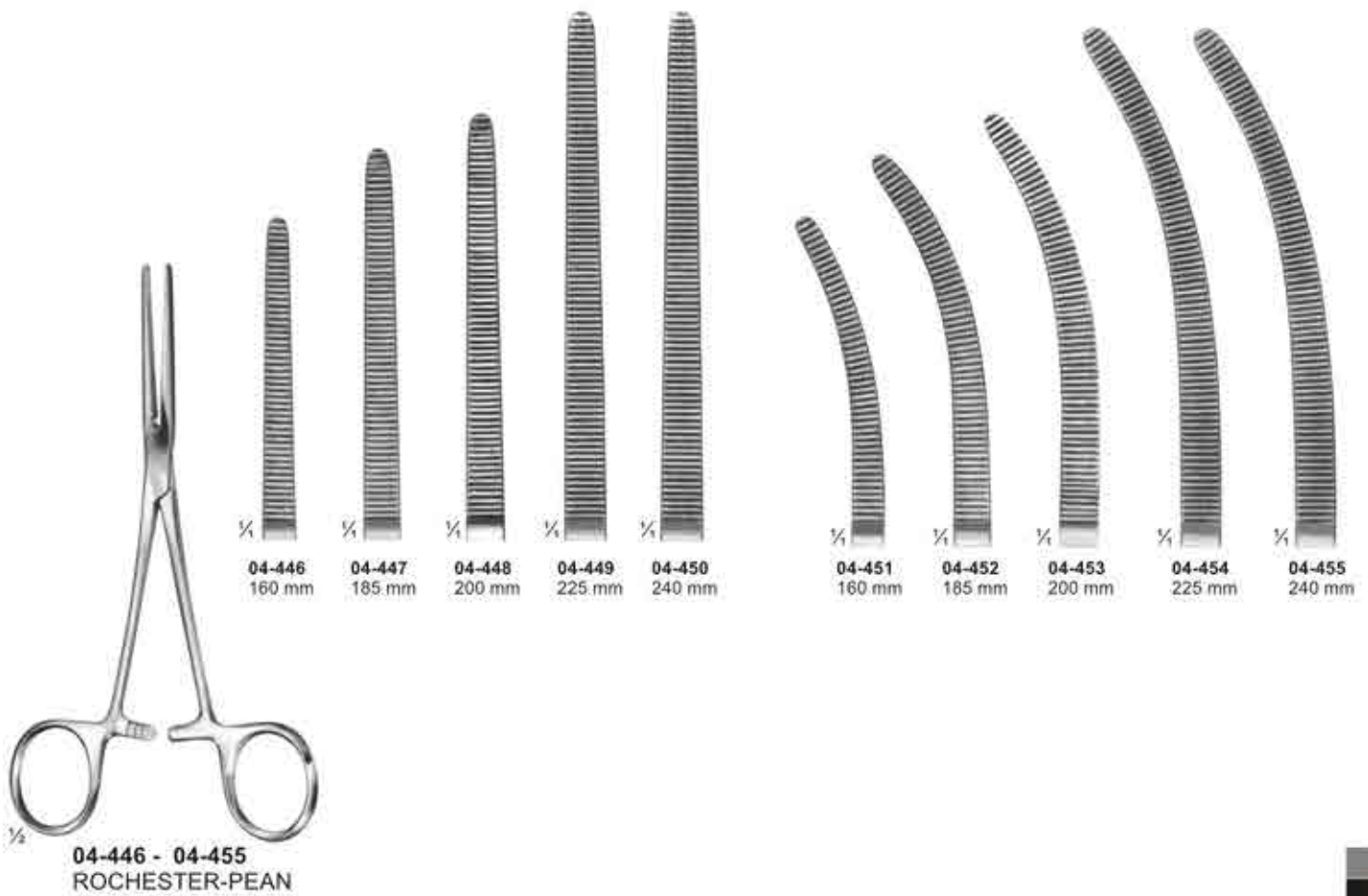

Haemostatic Forceps



04-456 - 04-461
PEAN

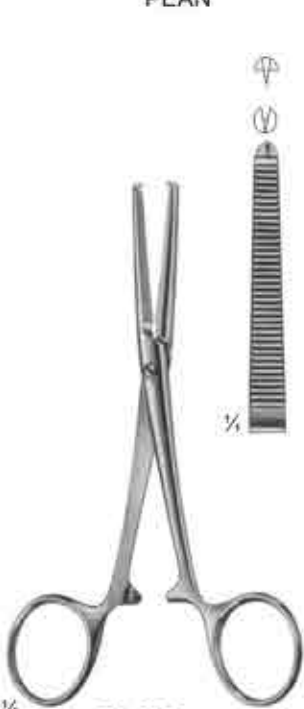
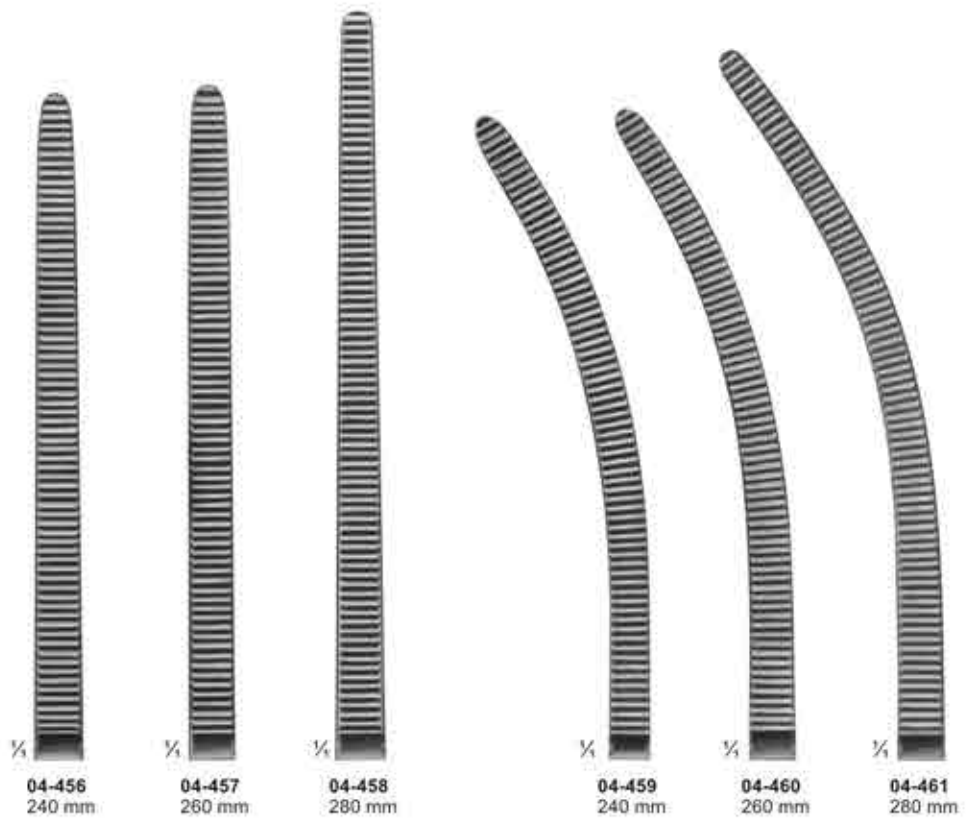

04-462
KOCHER
Strong Pattern
145 mm

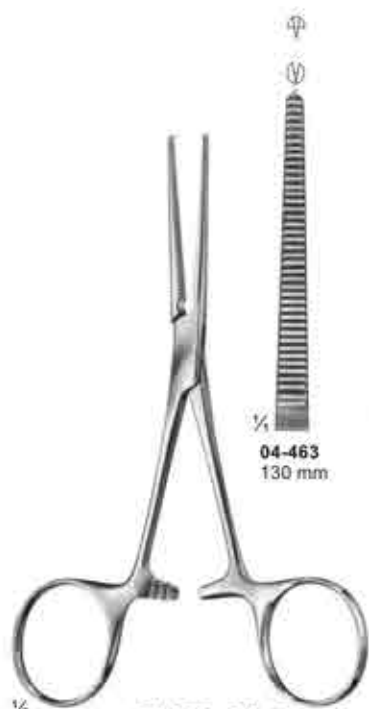

04-463 - 04-465
KOCHER

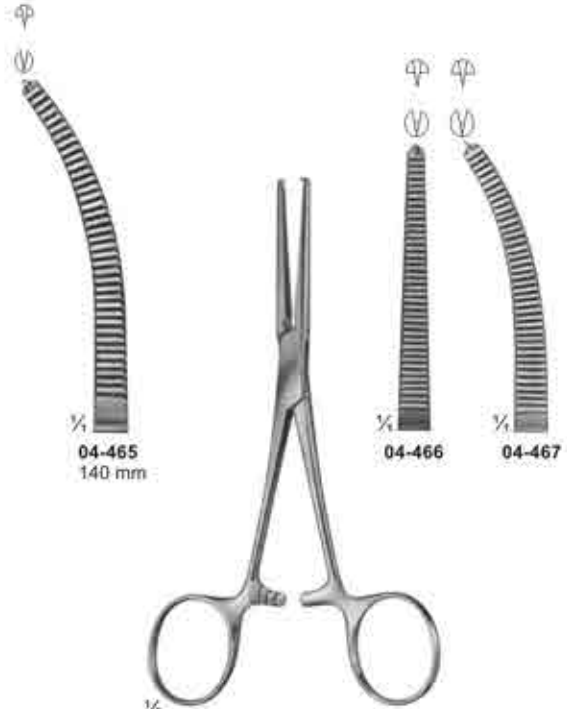

04-466 - 04-467
ROCHESTER-OGHSNER
140 mm

Haemostatic Forceps

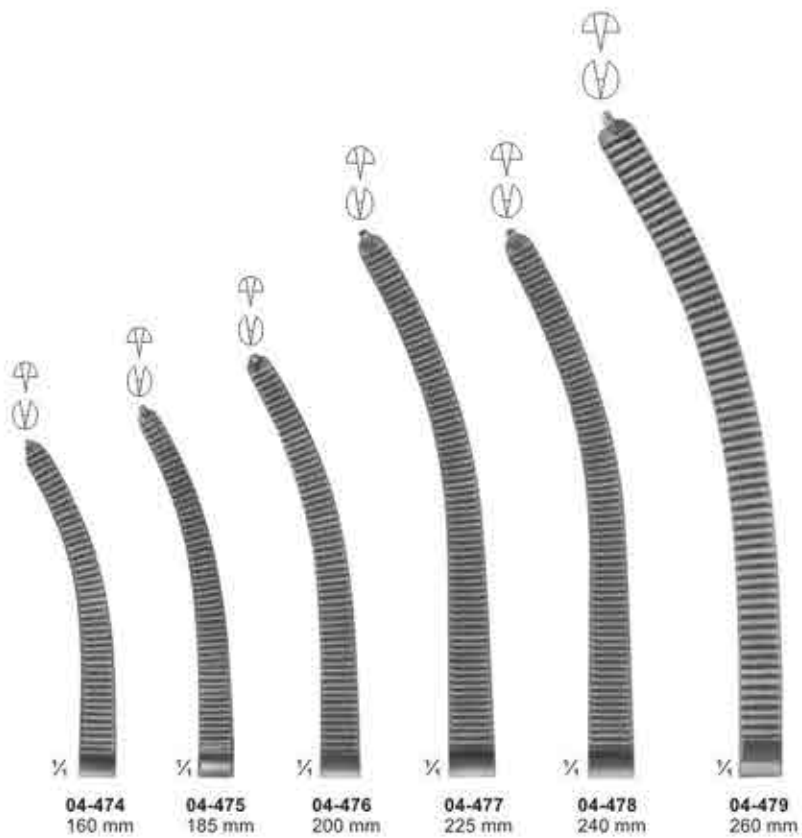
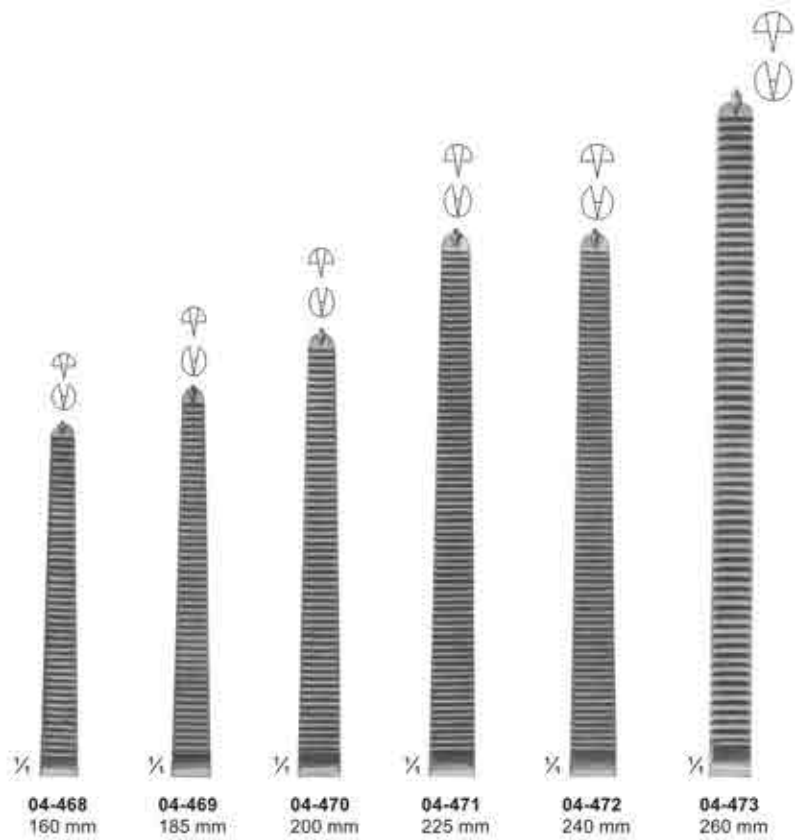

04-468 - 04-479
KOCHER-OCHSNER

Haemostatic Forceps



04-480
FRICKE
Artery forceps
130 mm



04-481
KRONLEIN
130 mm



04-482
PEAN
125 mm



04-483
125 mm



04-484
140 mm

04-483 - 04-484
PEAN



04-485
PEAN
125 mm

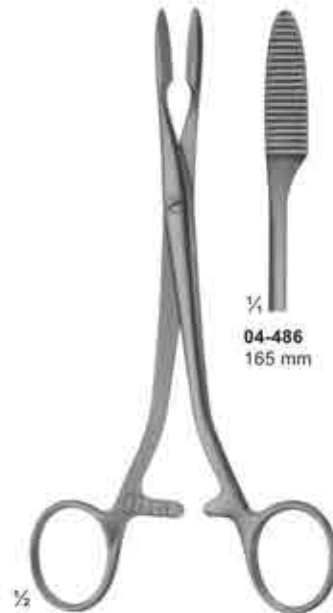

04-486
165 mm



04-487
185 mm

04-486 - 04-487
PEAN

Haemostatic Forceps, Special Pattern, Tonsil Forceps



Dissecting- and Ligature Forceps



1/2
04-500
 MIXTER-O'SHAUGHNESSY
 190 mm

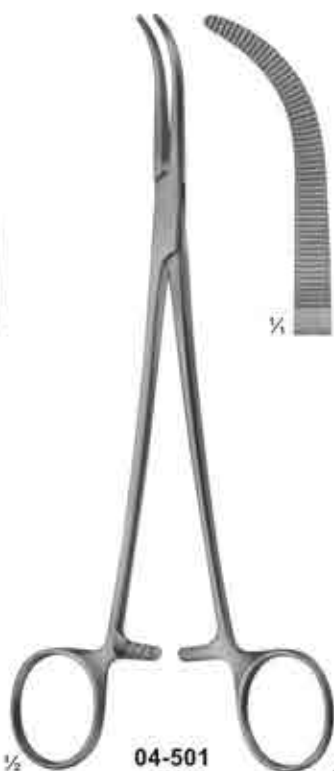

1/2
04-501
 HEISS
 195 mm

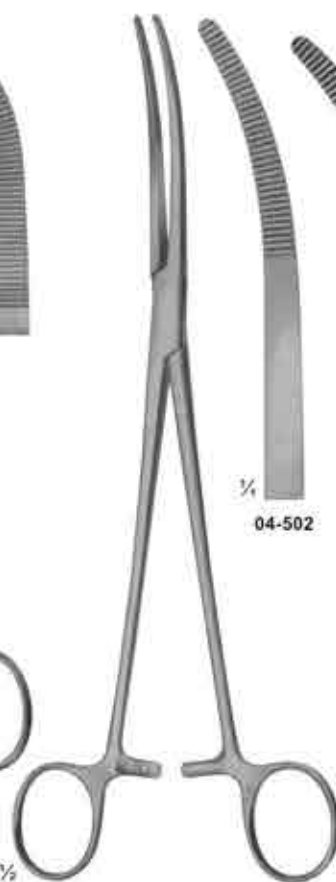

1/2
04-502 - 04-506
 RUMEL
 240 mm



1/2
04-507
 FINOCHIETTO
 245 mm



1/2
04-508
 MIXTER
 230 mm



1/2
04-509
 LAWRENCE
 270 mm

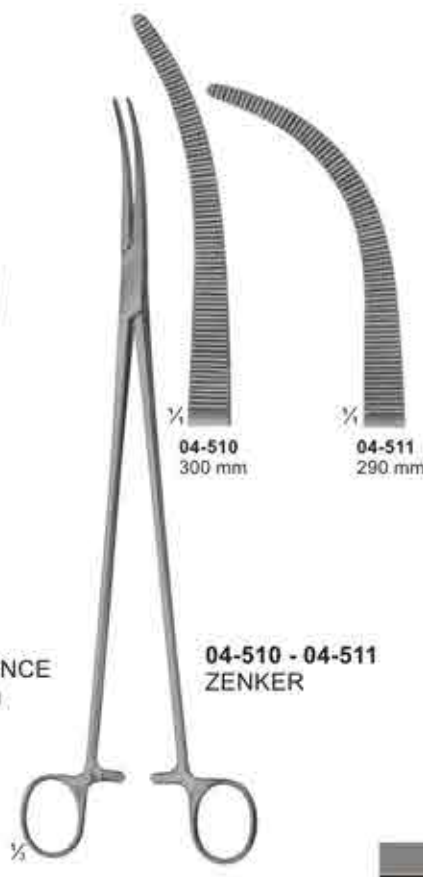

1/2
04-510 - 04-511
 ZENKER

**Hysterectomy Forceps, Vaginal Clamps
and Compression Forceps**



04-512
WERTHEIM
Hysterectomy forceps
255 mm



1/2



04-513
WERTHEIM
Parametrium clamp
260 mm



1/2



04-514 - 04-516
DICK



1/2

04-514
255 mm

04-515
265 mm

04-516
275 mm

Hysterectomy Forceps, Vaginal Clamps
and Compression Forceps



04-517
WERTHEIM
250 mm

04-520
80 mm



04-518
WERTHEIM-CULLEN
215 mm

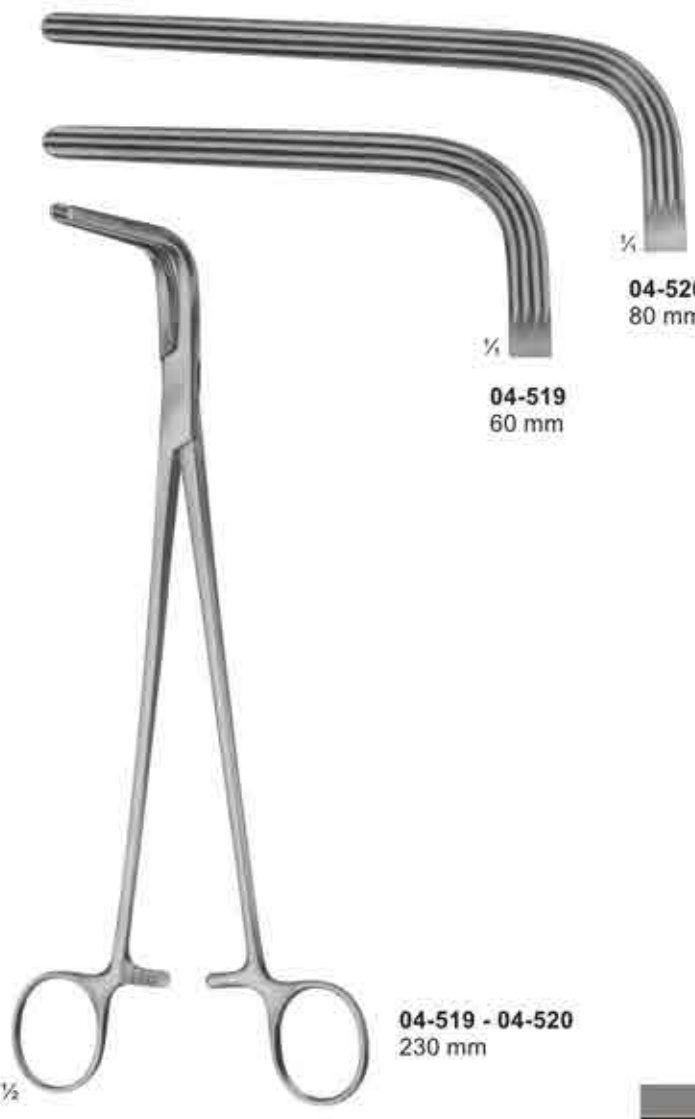

04-519 - 04-520
230 mm

Needle Holders for micro surgery



05-101
ROHRSCHEIDER
with copper inserts
100 mm



05-102
KALT
with catch
135 mm



05-103
ARRUGA
with catch
135 mm



05-104 - 105
CASTROVIEJO
with catch
145 mm



05-106 - 107
without Catch
160 mm



05-108 - 109
without catch
185 mm



05-110 - 111
JACOBSON
185 mm



05-112
without catch
195 mm



05-113 - 114
YASARGIL
with catch
200 mm

Needle Holders

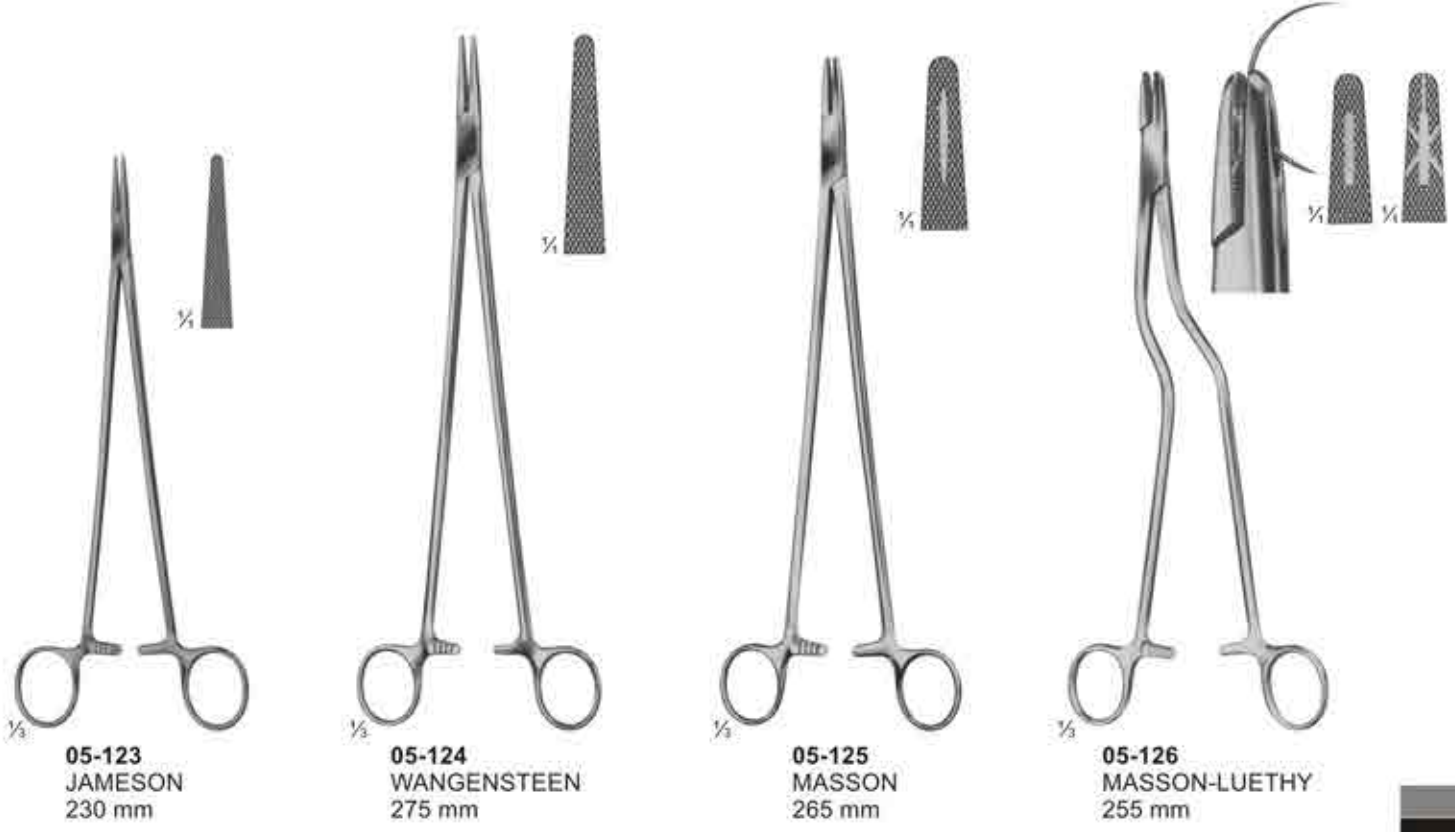

Needle Holders



05-127 - 128
HEGAR-OLSEN
255 mm

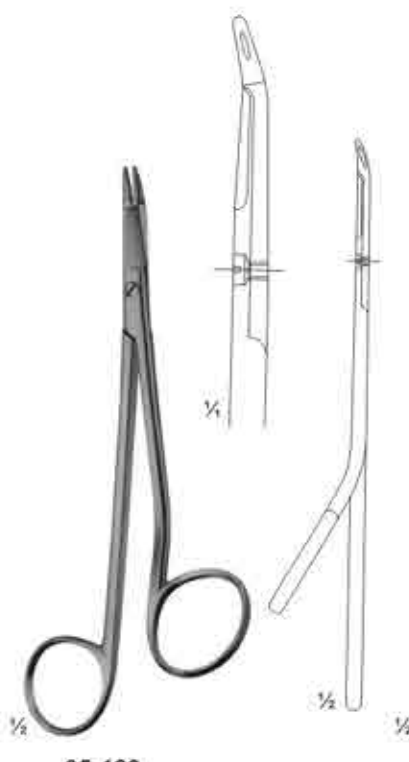

05-129
GILLIES
150 mm



05-130
GILLIES
160 mm



05-131
EISELSBERG
115 mm

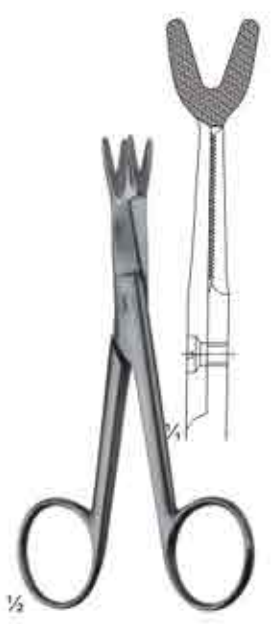

05-132
SCHOEMAKER-LOTH
125 mm



05-133
CRILE
150 mm



05-134
TOENNIS
Elastic pattern for dura-or
intestinal suture. 180 mm

Needle Holders

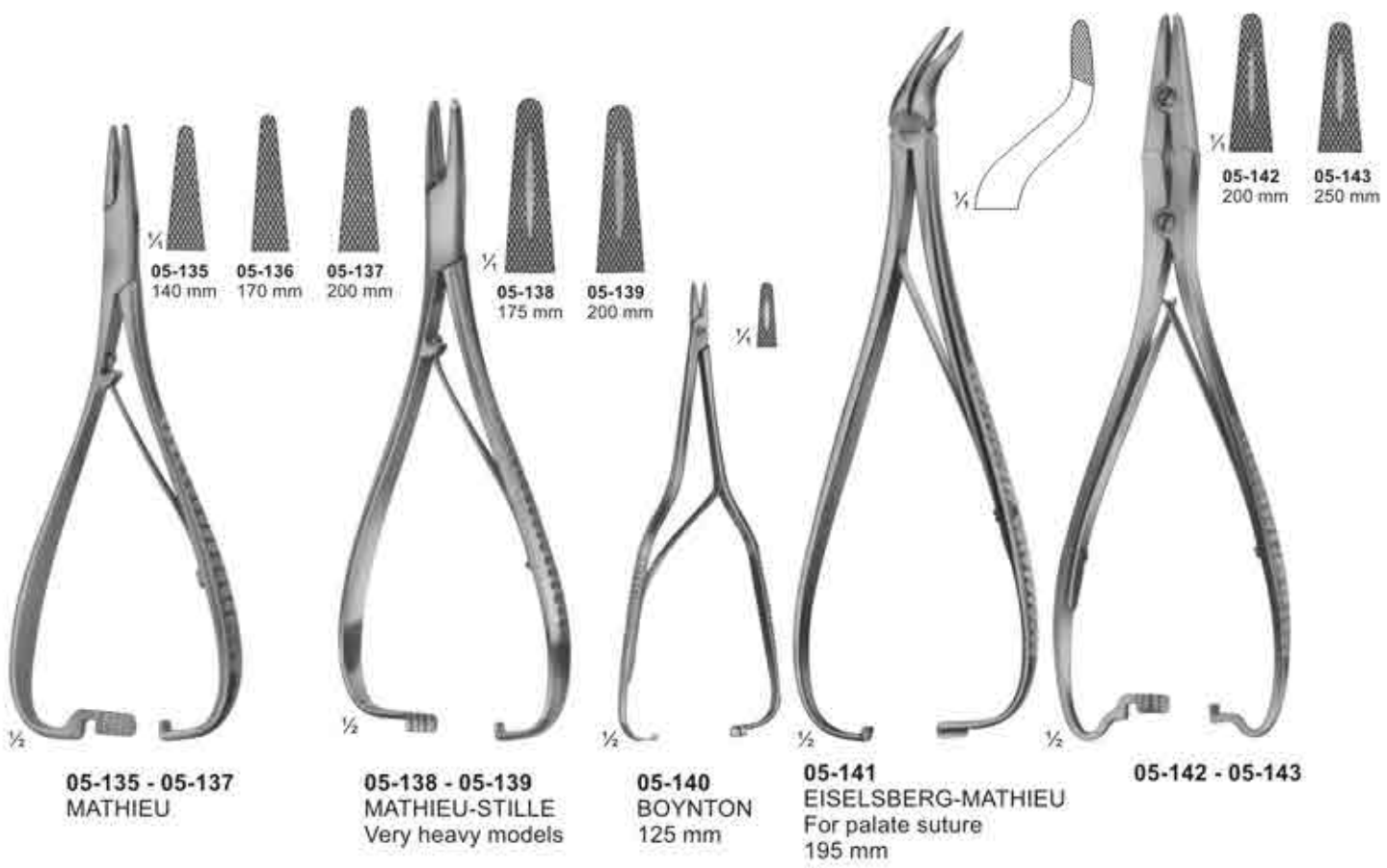

Suture Instruments - Reverdin Needles

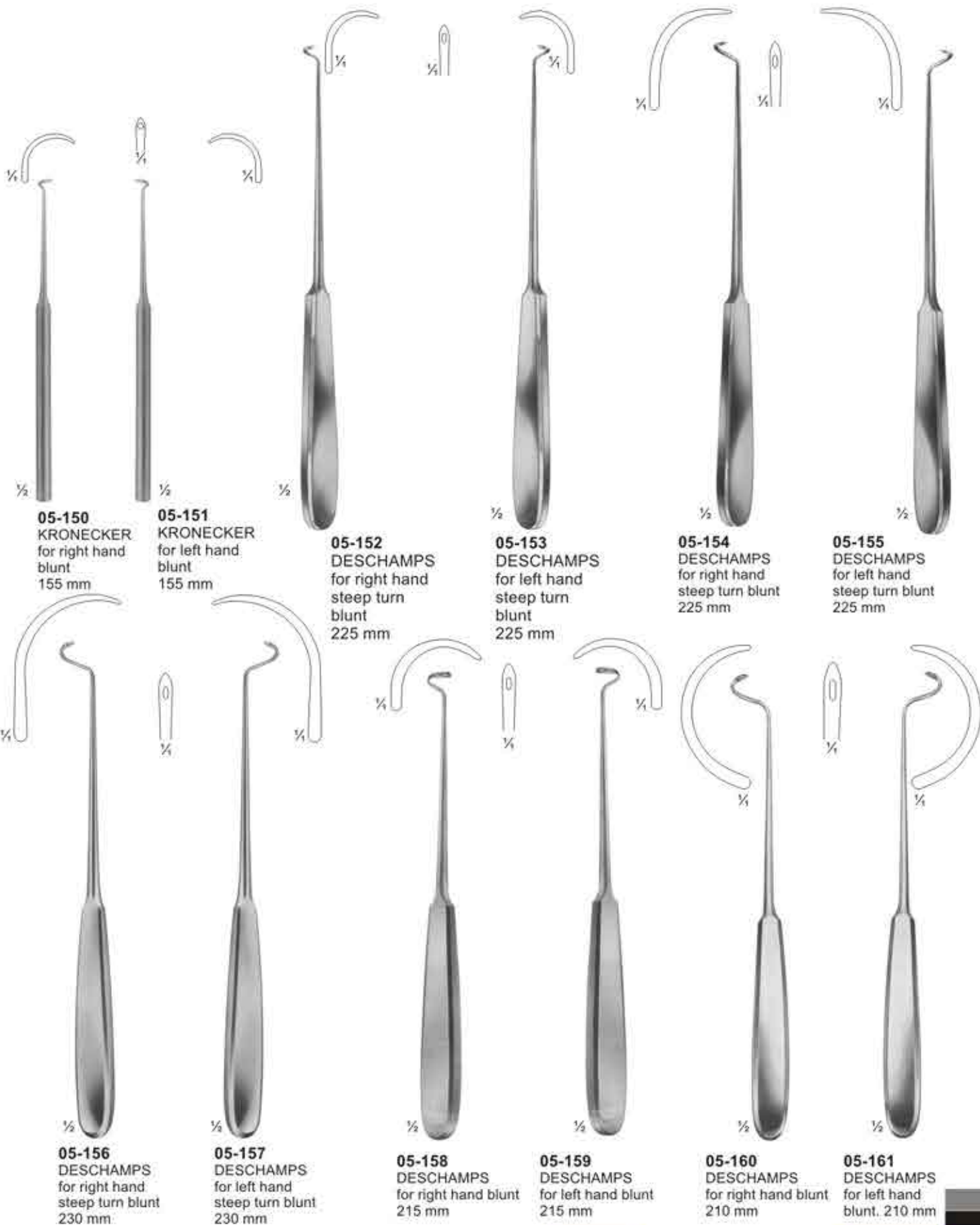

Probes



05-162 130 mm
05-163 145 mm
05-164 160 mm
Directors



05-165
DOYEN
145 mm
Directors



05-166
NELATON
160 mm
Directors



05-167
Director with tip
Diam. Of tip 3,3 mm
140 mm

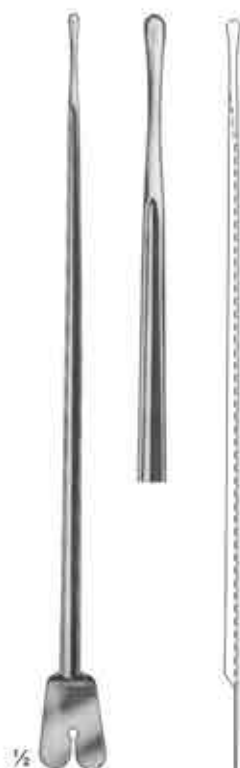

05-168
BRODIE
Director with tip,
Diam. Of tip 3,5 mm
200 mm



05-169
LOCKHART-MUMMERY
165 mm



05-170
LOCKHART-MUMMERY
165 mm

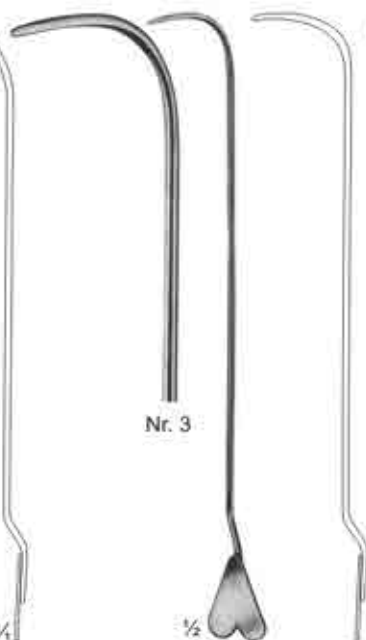

05-171
LOCKHART-MUMMERY
165 mm

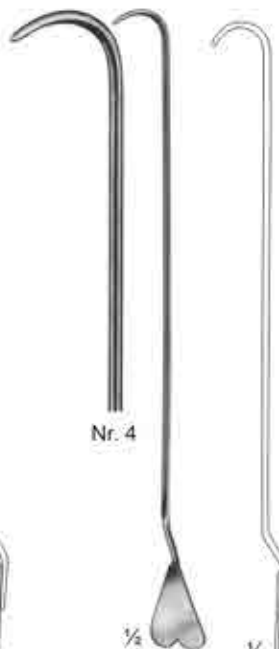

05-172
LOCKHART-MUMMERY
165 mm



05-173
Director with wire
loop, malleable
190 mm

Probes



05-174 145 mm
 05-175 160 mm
 05-176 200 mm
 Probes with eye



05-177
 Myrtle leaf probe
 145 mm



05-178 130 mm
 05-179 145 mm
 05-180 160 mm
 05-181 180 mm
 05-182 200 mm



05-183
 Probes



05-184
 Double ended probe,
 malleable, diam. of tips
 3 mm with hole
 190 mm



05-185
 Double ended probes,
 tin, malleable,
 diam. of tips
 3,5 mm with hole
 250 mm, 300 mm



05-186
 Double ended probes,
 tin, malleable,
 diam. of tips 4 mm
 400 mm



05-187 1,5 mm
 05-188 2,0 mm
 05-189 2,5 mm
 300 mm

Suturing Instrument Set, Pocket Instrument Set



05-190

Suturing instruments set, in metal case consisting of: Scissors, curved, sharp/sharp, 115mm
25 MICHEL clip, 16 x 3mm
1 Delicate tissue forceps, 130mm
1 Scalpel, bellied
1 MATHIEU needle holder, 140mm
1 Perforated metal case, stainless containing:
1 Suture needle
1 item 1 item



05-191

Pocket instrument set, in metal case consisting of:

Bottom tray

1 MATHIEU needle holder, 140mm
1 MICHEL clip forceps, combined
1 Myrtle leaf probe, 130mm
1 Sharp double curette
1 Skin hook
1 Detachable scalpel handle, no.4
1 Perforated metal case, containing
6 Scalpel blades
1 Perforated metal case, stainless, containing
1 Suture needle
1 item
1 item

Top tray

1 Tissue forceps, 130mm
1 KOCHER haemostatic forceps, 130mm
1 Straight surgical scissors, 130mm
1 Dissecting forceps, 130mm
1 FEILCHENFELD splinter forceps, 115mm
25 MICHEL clip, 16 x 3mm
1 Flacon of suture skin, sterile in alcohol



05-192

Pocket instrument set, in metal case consisting of:

Bottom tray

1 MAYO-HEGER needle holder, 150mm
1 MICHEL clip forceps, combined
1 Myrtle leaf probe, 130mm
1 Sharp double curette
1 Skin hook
1 Detachable scalpel handle, no. 4
1 Perforated metal case, consisting
6 Scalpel blades
1 Perforated metal case, stainless, consisting:
1 Suture needle
1 item, & 1 item

Top tray

1 Tissue forceps, 130mm
1 CRILE haemostatic forceps, 140mm
1 Straight surgical scissors, 130mm
1 Dissecting forceps, 130mm
1 FEILCHENFELD splinter forceps, 115mm
25 MICHEL clip, 16 x 3mm
1 Flacon of suture silk, sterile in alcohol

Fine Wound Retractors (Dura- and Skin Retractors)

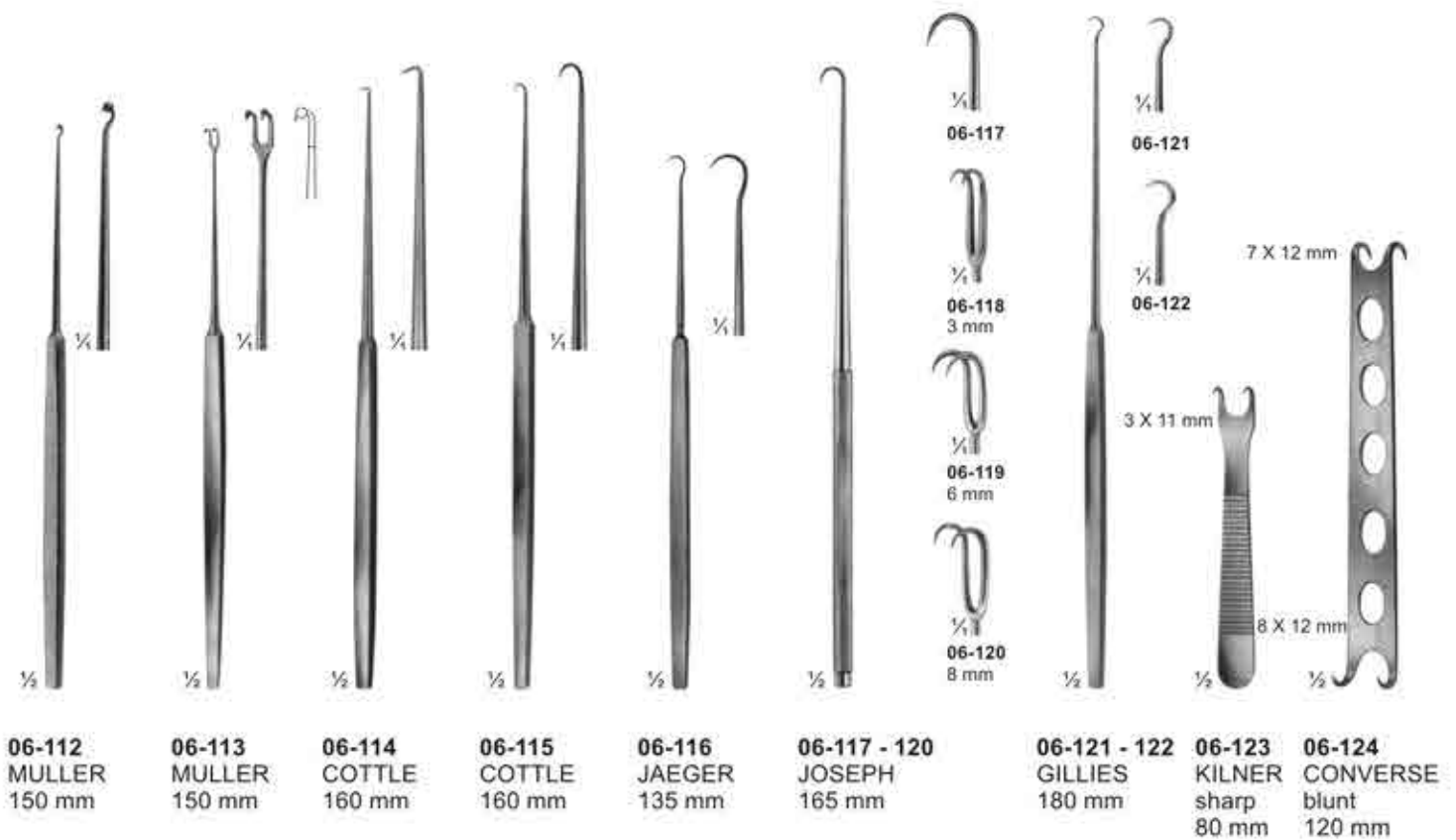
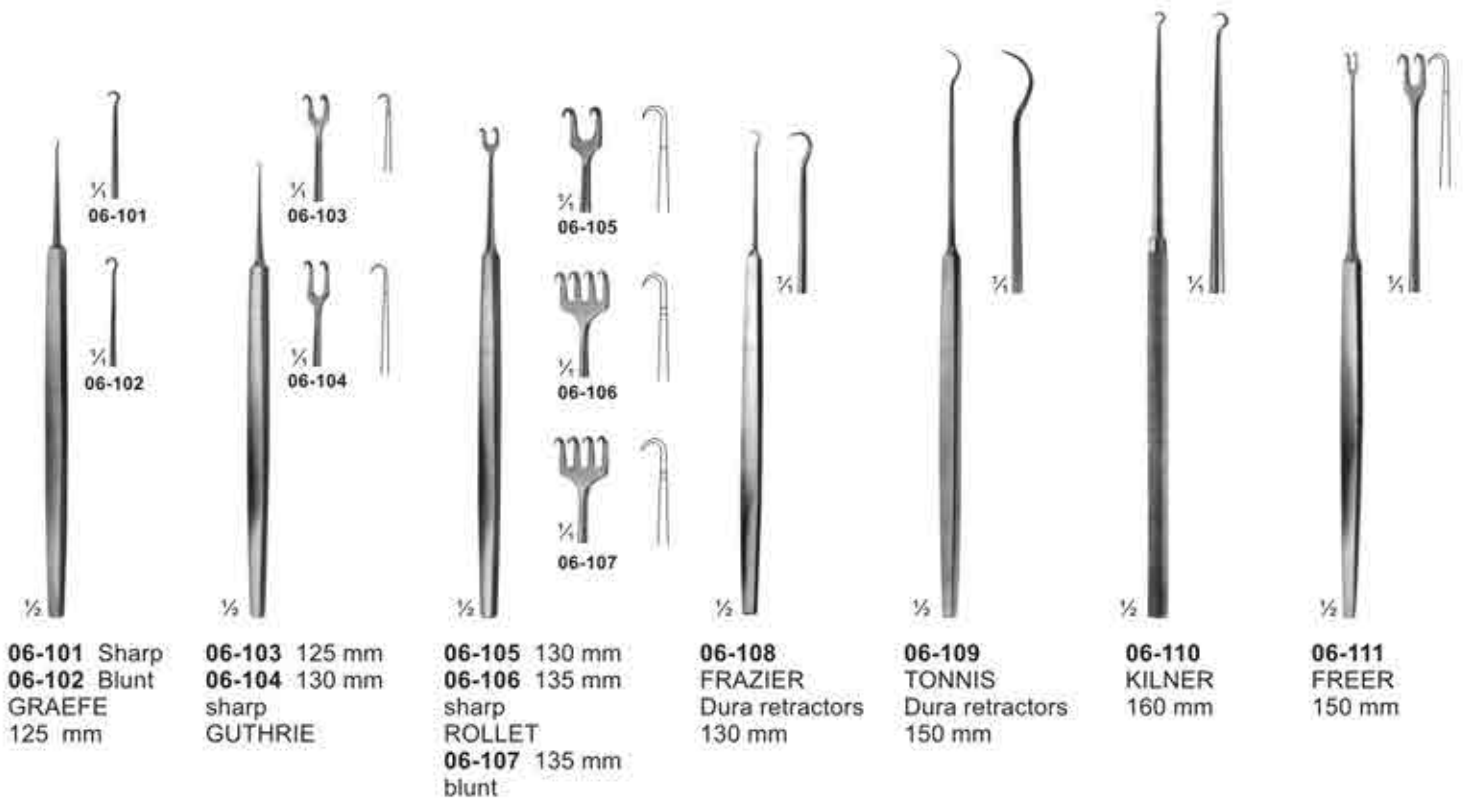

Retractors With treangle handle

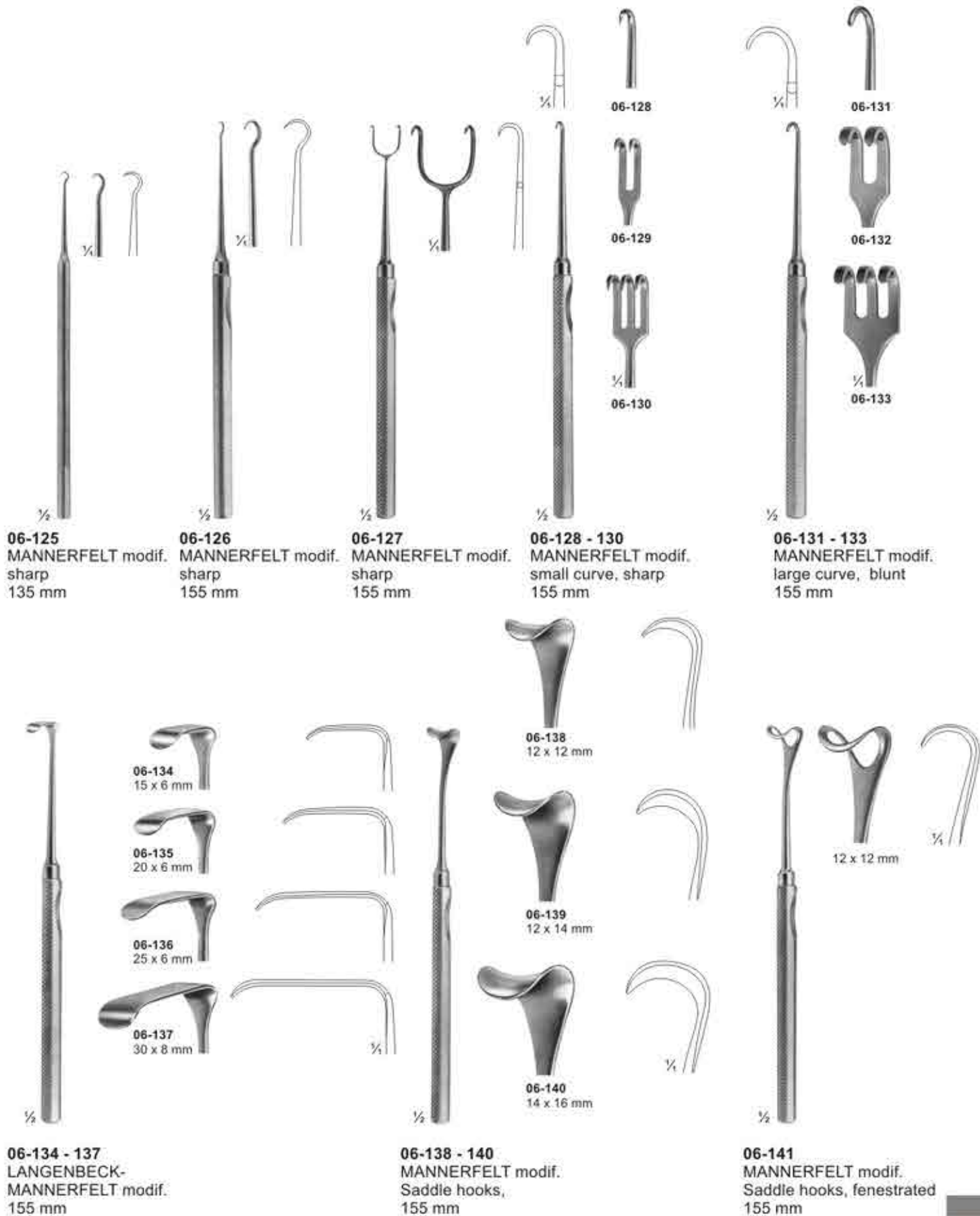

Retractors



06-142
MASING
140 mm



06-143
COTTLE
140 mm



06-144 - 148
DESMARRES
140 mm



06-145
9 x 12 mm



06-146
11 x 14 mm



06-147
12 x 16 mm



06-148
13 x 18 mm



06-149
13 x 13 mm



06-150
12 x 16 mm

06-149 - 150
KONIG
180 mm



10 x 10 mm

06-151
CUSHING-KOCHER
175 mm



06-152 - 153
KOCHER
205 mm



06-152
20 x 12 mm



06-153
20 x 15 mm



06-154
SCHOENBORN
200 mm



13 x 6 mm

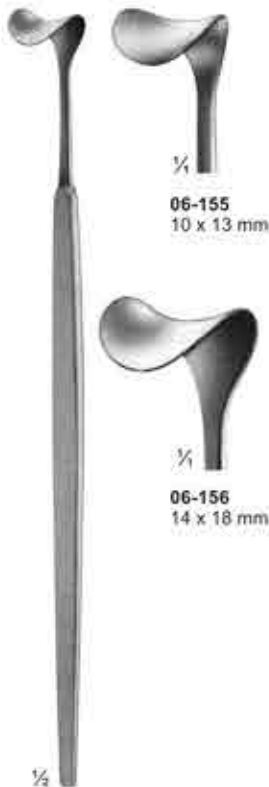

06-155 - 156
CUSHING
205 mm



06-155
10 x 13 mm



06-156
14 x 18 mm



06-157
205 mm

20 x 15 mm

20 x 19 mm



06-158
11 x 14 mm



06-159
13 x 18 mm

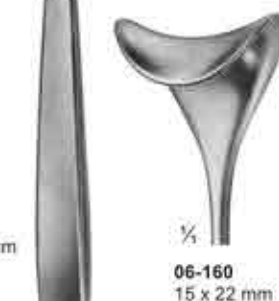

06-158 - 160
CUSHING
250 mm

06-160
15 x 22 mm

Retractors

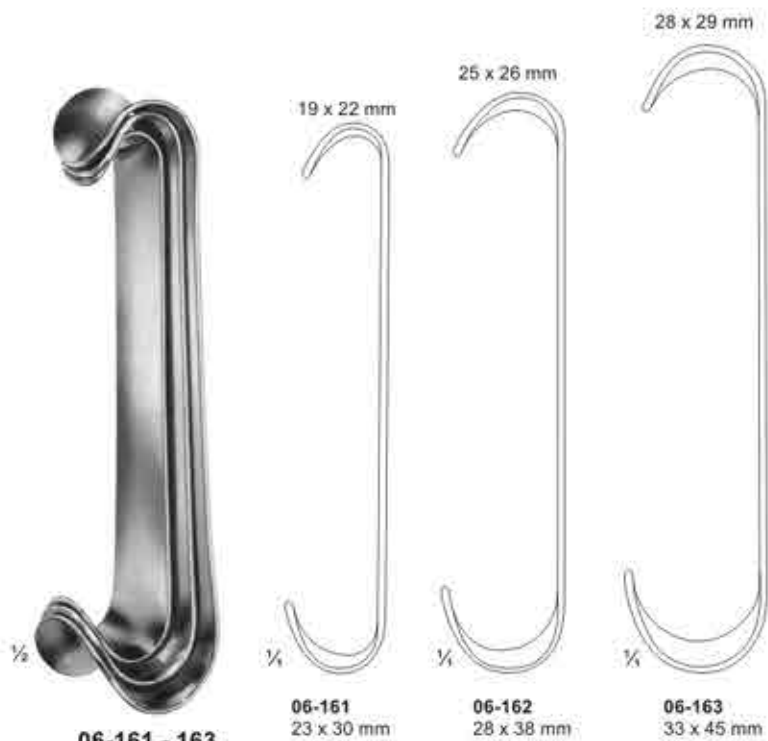

06-161 - 163
ROUX
Set
165 mm

06-161
23 x 30 mm

06-162
28 x 38 mm

06-163
33 x 45 mm



06-164 - 165
ROUX

06-164
25 x 29 mm
150 mm

06-165
30 x 38 mm
160 mm

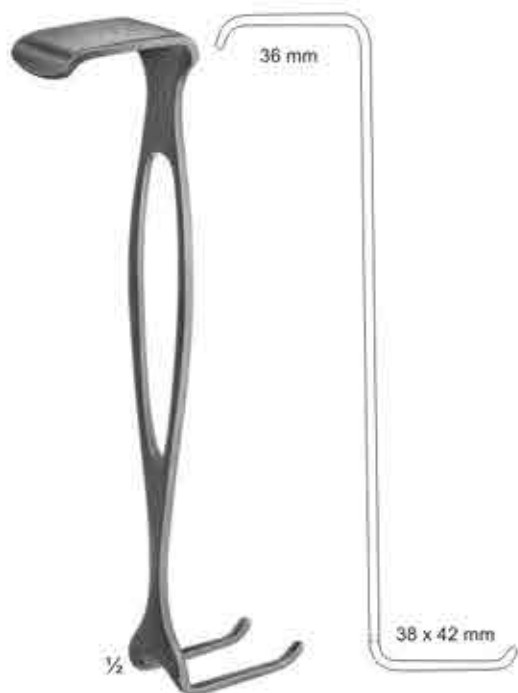

06-166
CZERNY
175 mm



06-167
MATHIEU
200 mm



06-168
US-ARMY
220 mm

Retractors

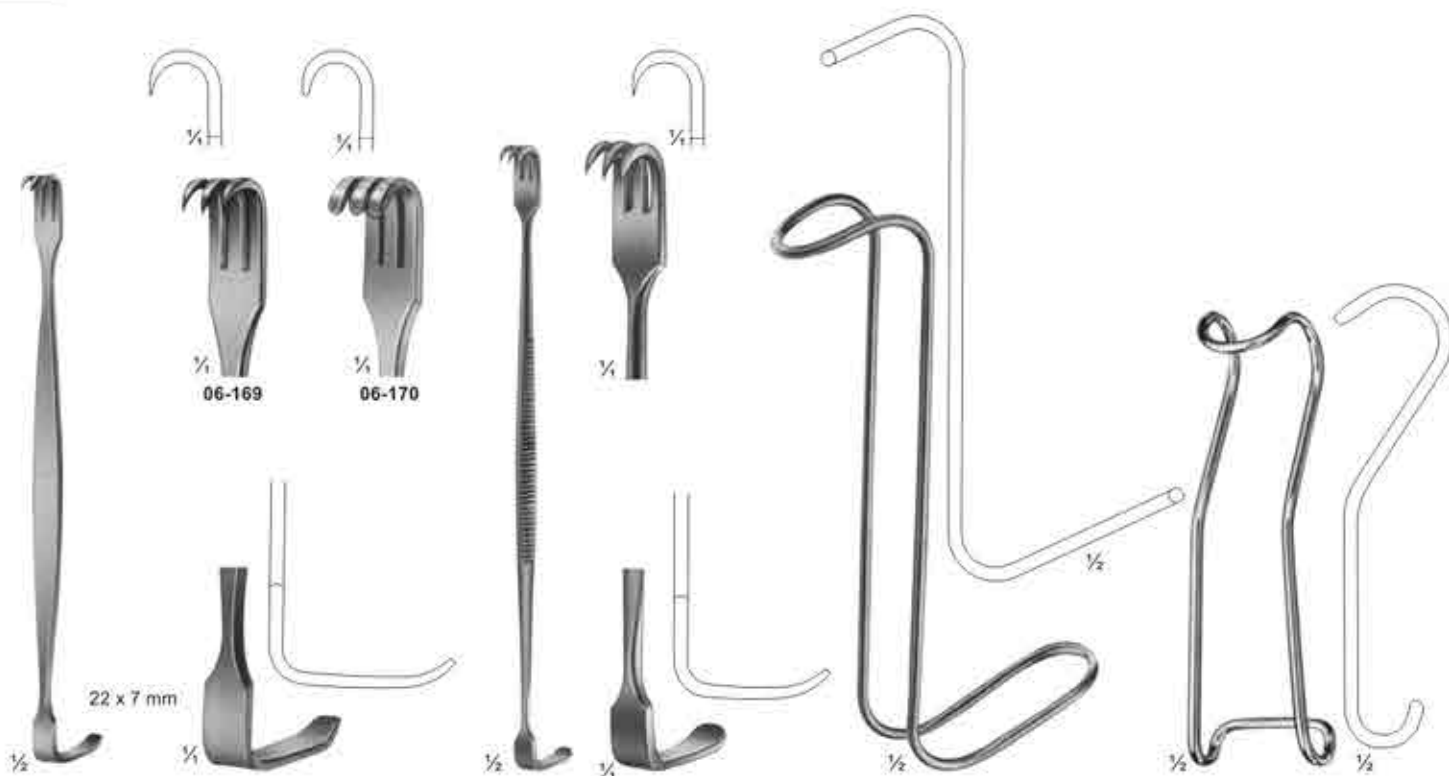

06-169 - 06-170
BABY-SENN-MILLER
 155 mm

06-171
SENN-MILLER
 165 mm

06-172
COLLIN-HARTMANN
 150 mm

STERBERG
06-173 120 mm
06-174 130 mm
06-175 135 mm
06-176 140 mm



06-177
LUER
 110 mm

06-178
ROSE
 130 mm

06-179
BABY-ROUX
 135 mm

06-180
PARKER
 135 mm

06-181
CRILE
 110 mm

06-182
FARABEUF
 150 mm

06-183
COLLIN
 150 mm

Bone Retractors and Retractors



06-184
KOCHER
sharp
205 mm



06-185
KOCHER
sharp
220 mm



06-186
KOCHER
sharp
220 mm



06-187
VOLKMANN
blunt
220 mm



06-188
VOLKMANN
sharp
220 mm



06-189 - 06-196
VOLKMANN
225 mm



Sharp

1/4



Blunt

1/4



06-189
9 x 8 mm



06-190
9 x 13 mm



06-191
9 x 19 mm



06-192
9 x 29 mm



06-193
8,5 x 8 mm



06-194
8,5 x 13 mm



06-195
8,5 x 19 mm



06-196
8,5 x 29 mm

Retractors



06-197 - 06-199
MIDDENDORPF



1/2
06-197
15 x 15 mm
220 mm



1/4



1/2
06-198
20 x 22 mm
215 mm



1/4



1/2
06-199
28 x 28 mm
235 mm



1/4



1/2
06-200
BUCHS
205 mm



38 x 18 mm



1/2
06-202
KOCHER
230 mm

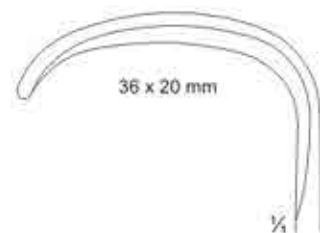

36 x 20 mm



67 x 17 mm

1/4



1/2
06-201
CASPAR
210 mm

Retractors, Vario Retractor System



- 06-203-06-209
BRUNNER
275 mm
- 06-203 80 x 20
 - 06-204 100 x 25
 - 06-205 120 x 25
 - 06-206 130 x 30
 - 06-207 140 x 30
 - 06-208 160 x 30
 - 06-209 180 x 30



Retractors, Lung Spatulas



**Retractors for deep surgery
(Abdominal Retractors)**



**06-216
MIKULICZ
255 mm**

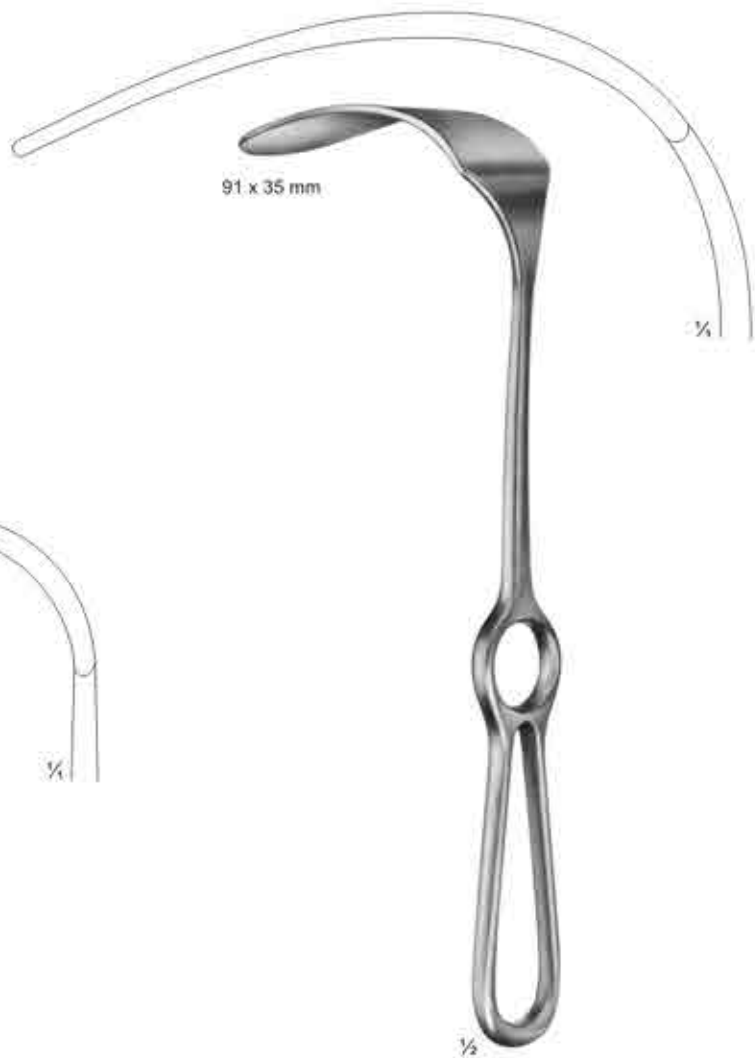

**06-217
MIKULICZ
250 mm**

Retractors, Abdominal Retractors



- 06-229 Fig.1 32 x 40 mm
- 06-230 Fig.2 34 x 50 mm
- 06-231 Fig.3 41 x 60 mm
- 06-232 Fig.4 46 x 75 mm
- 06-233 Fig.5 64 x 85 mm

06-218 - 06-228
DOYEN
240 mm

06-229 - 06-233
FRITSCH
240 mm

06-234
DOYEN
250 mm

	width of blades	35 mm, 45 mm, 60 mm
length of blades		
62 mm	06-218 , 06-222 , 06-226	
92 mm	06-219 , 06-223 , 06-227	
122 mm	06-220 , 06-224 , 06-228	
160 mm	06-221 , 06-225	

Abdominal- and Intestinal Spatulas
Bauch- und Darmspatel



06-235
LERICHE
 255 mm

06-236
KUMMEL
 Mealleable
 285 mm

06-237
MIKULICZ
 29 mm
 250 mm

06-238 - 06-239
KADER
06-238 30 mm
06-239 40 mm
 270 mm

Self-Retaining Retractors



06-240
WEITLANER
sharp
130 mm

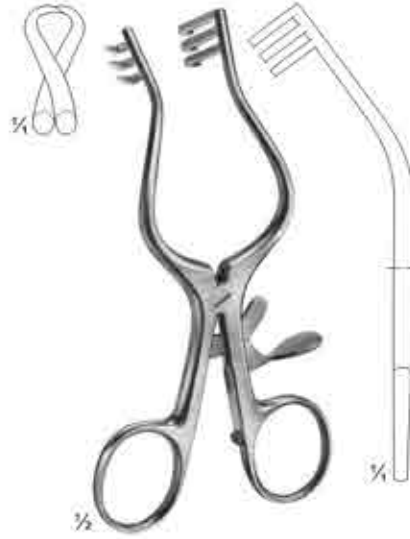

06-241
WULLSTEIN
sharp
130 mm

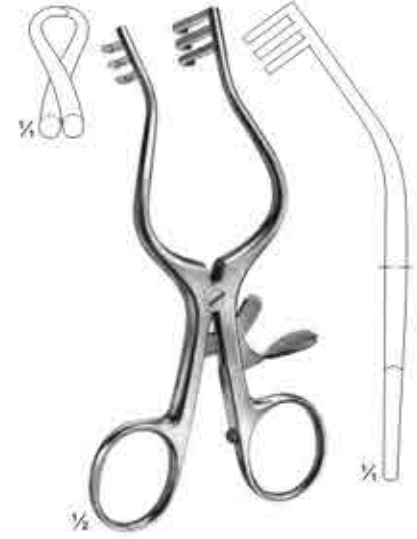

06-242
WULLSTEIN
blunt
130 mm



06-243
WEITLANER
sharp
165 mm



06-244
PLESTER
blunt
110 mm



06-245
PERKINS
blunt
130 mm

Special Retractors



06-246
JOLL (FRIEDMAN)
 Thyroid- and vaginal retractor
 155 mm



06-247
JACKSON BURROWS
 Retractor, blunt
 185 mm



06-248
GELPI
 Vaginal retractor
 135 mm



06-249
GELPI
 Skin- and vaginal retractor
 175 mm



06-250
DE BAKEY
 Femur retractor
 145 mm

Lamina Spreaders



06-251
CLOWARD
155 mm



06-252
CLOWARD
135 mm



06-253
INGE
170 mm

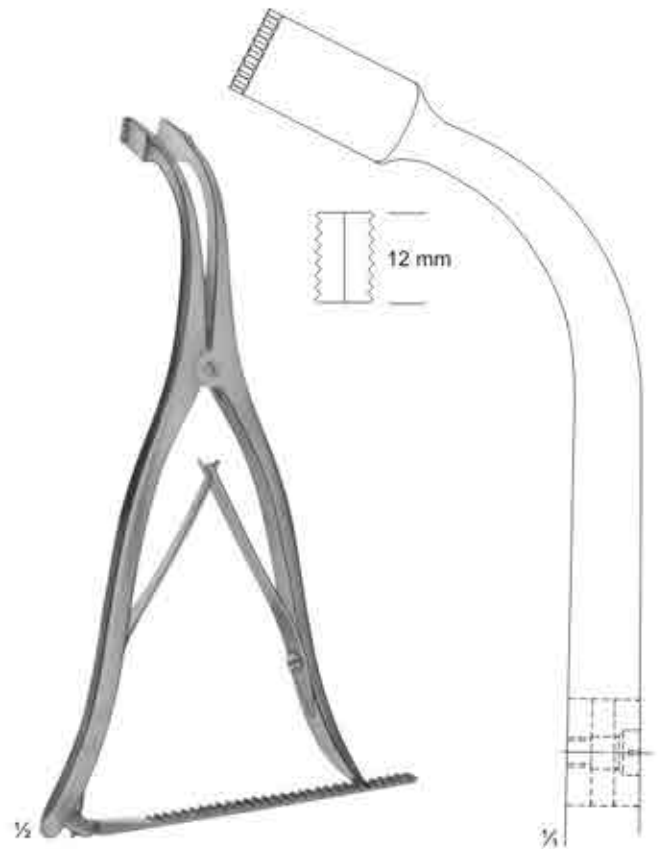

06-254
INGE
275 mm

Abdominal Retractors



06-255
GOSSET
Blades: 38 mm deep



06-256
HERTZLER
Blades 20 X 25 mm



06-257
BALFOUR-BABY
Lateral blades 27 mm deep
Center blade 21x24 mm

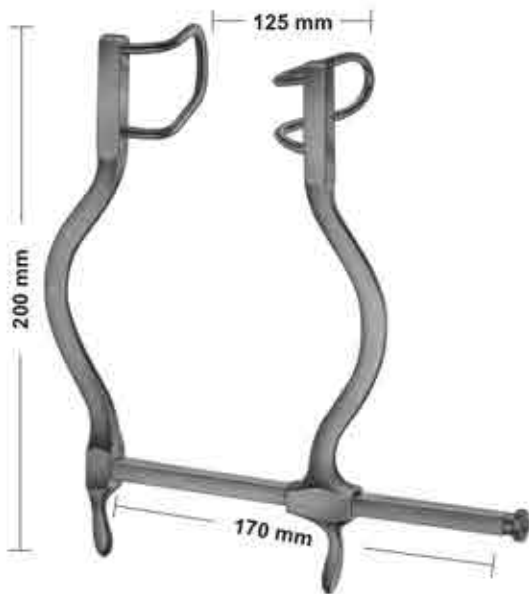

06-258
GOSSET
Blades: 55 mm deep

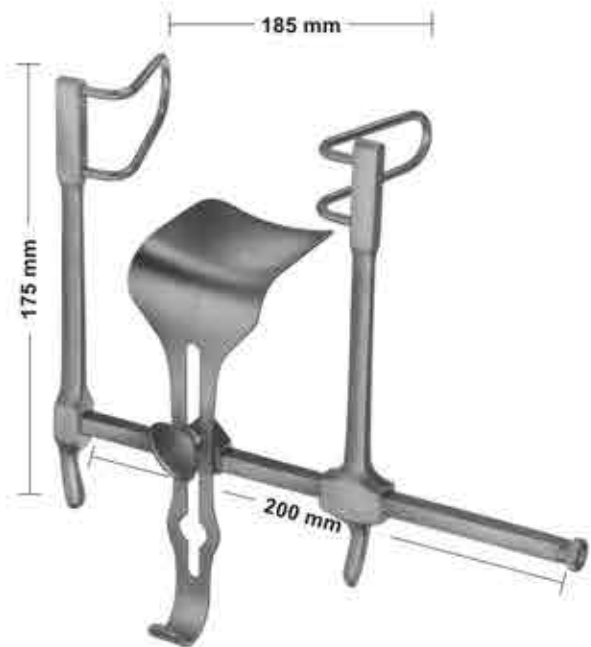

06-259
GOSSET
Lateral blades 58 mm deep
Center blade 59 x 57 mm

Abdominal Retractors

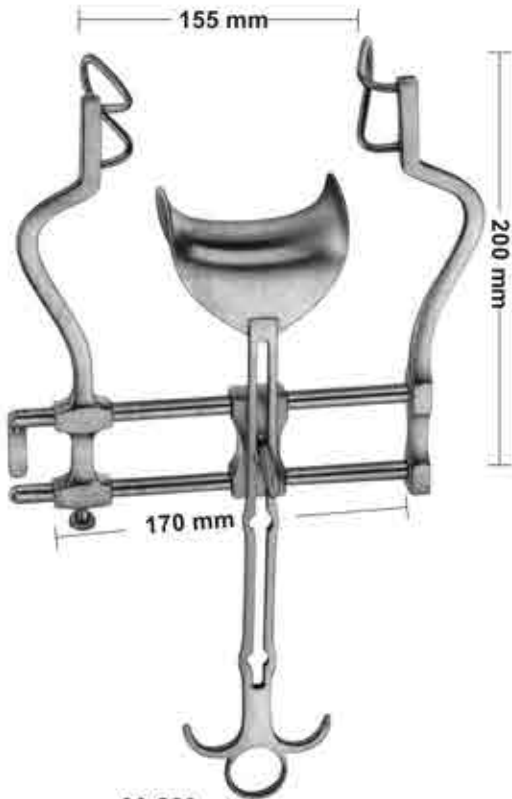

06-260
BALFOUR
Lateral blades 60 mm deep
Center blade 47 x 80 mm

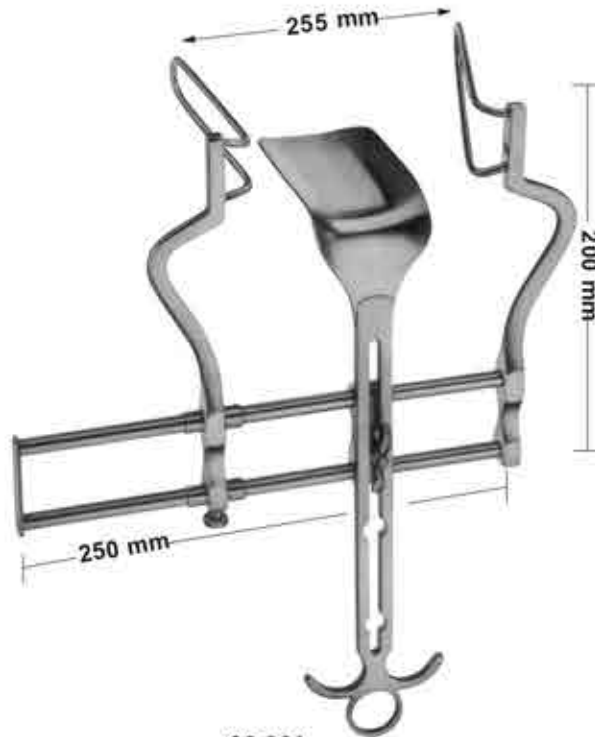

06-261
BALFOUR
Lateral blades 105 mm deep
Center blade 107x 59 mm



06-262
Center blade only
54x80 mm

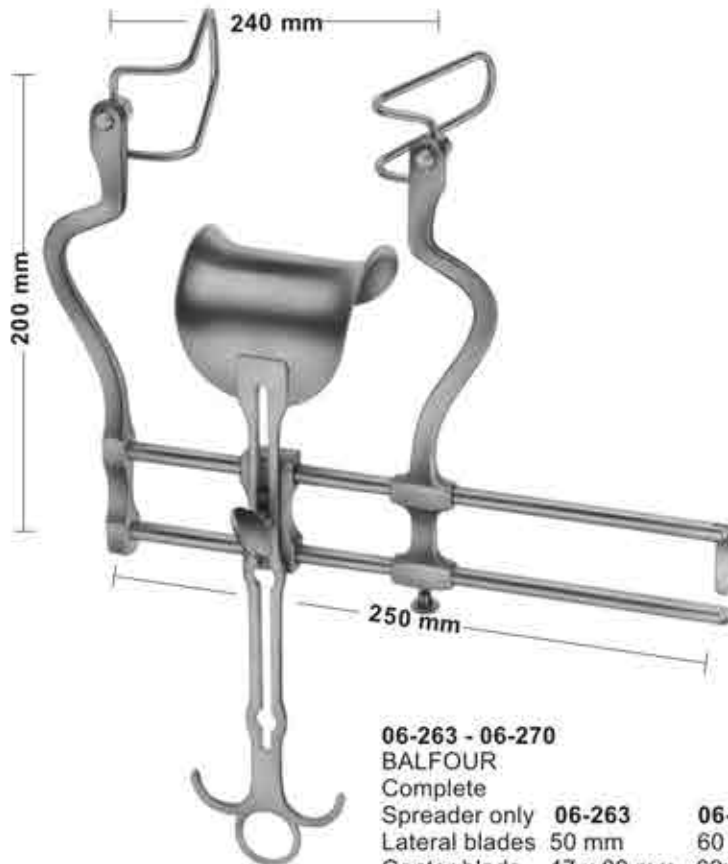

06-263 - 06-270
BALFOUR
Complete

Spreader only	06-263	06-264	06-265	06-266
Lateral blades	50 mm	60 mm	75 mm	90 mm
Center blade	47 x 80 mm	62x76 mm	80x80 mm	80x80 mm



Lateral blades
06-267 50 mm deep
06-268 60 mm deep
06-269 75 mm deep
06-270 90 mm deep
 Sales Unit of blades: PR = pair

Organ-, Tissue and Intestinal Grasping Forceps

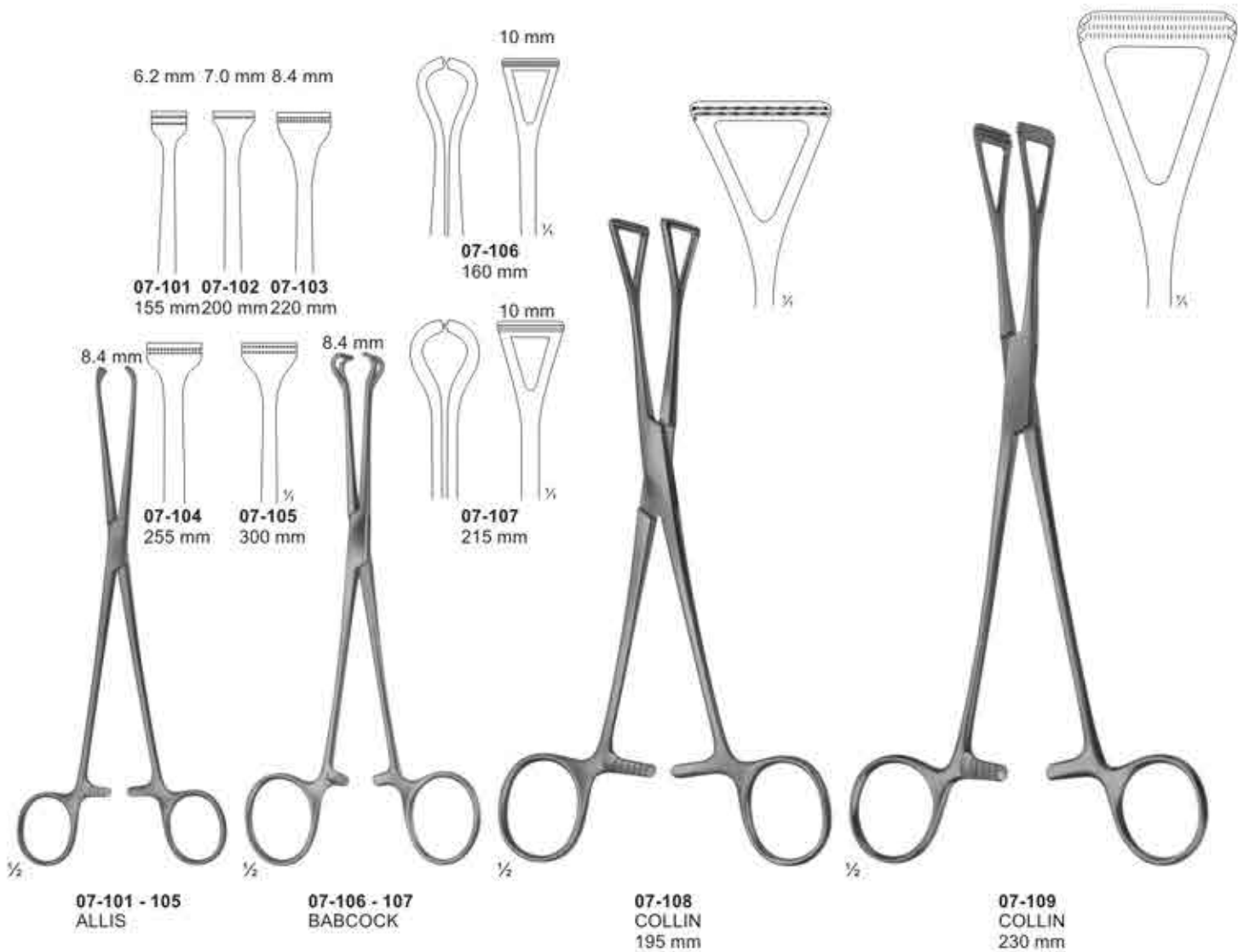

Intestinal Clamps, soft elastic

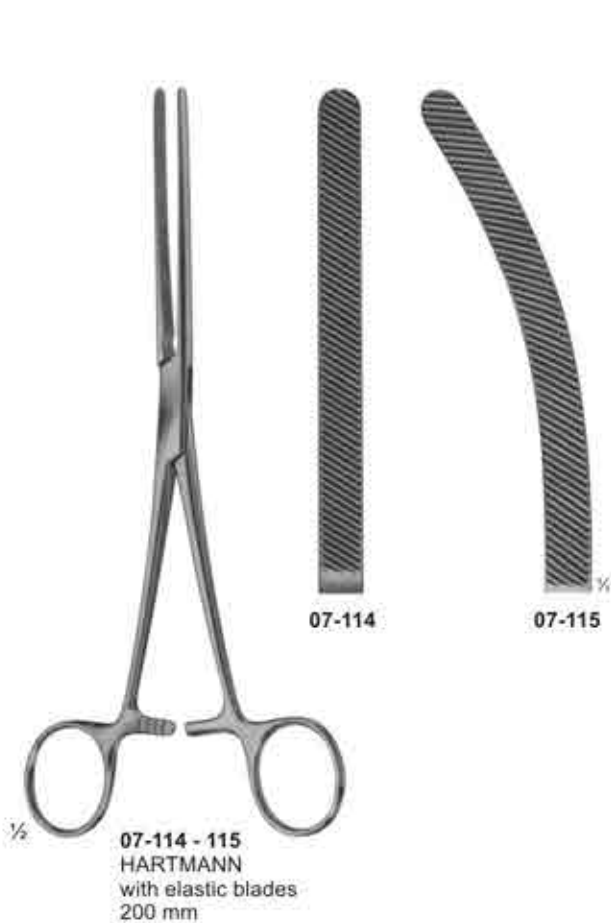
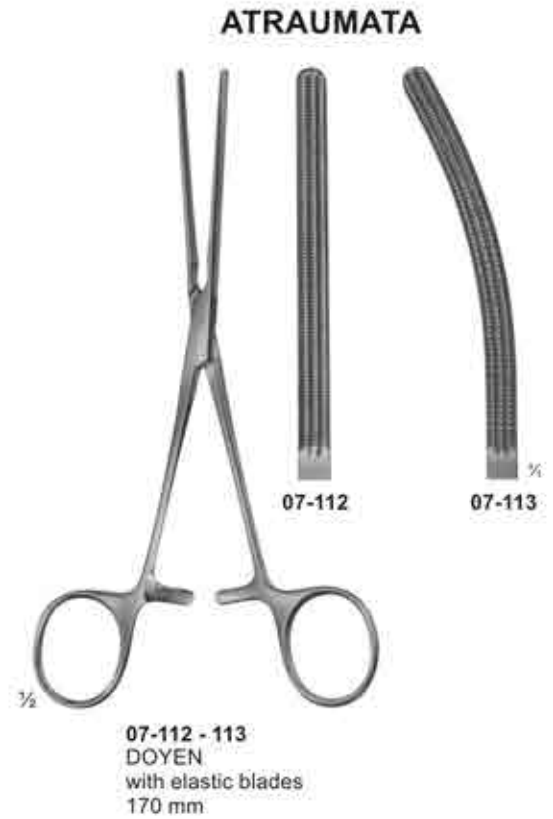
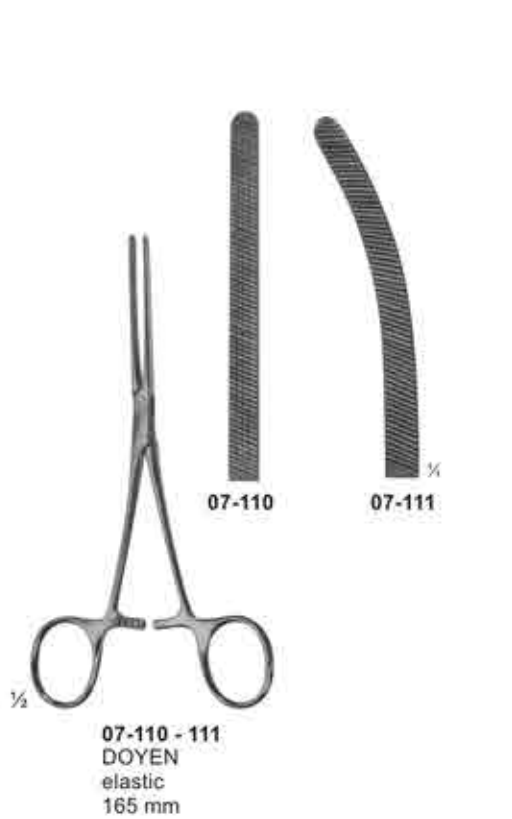

Intestinal and Pylorus Clamps



07-118
PAYR
Intestinal clamp
light pattern,
for children
180 mm

07-119
PAYR
200 mm

07-120
PAYR
275 mm

07-121
PAYR
Pylorus clamp
315 mm

ATRAUMATA
Sigmoid Anastomosis Forceps

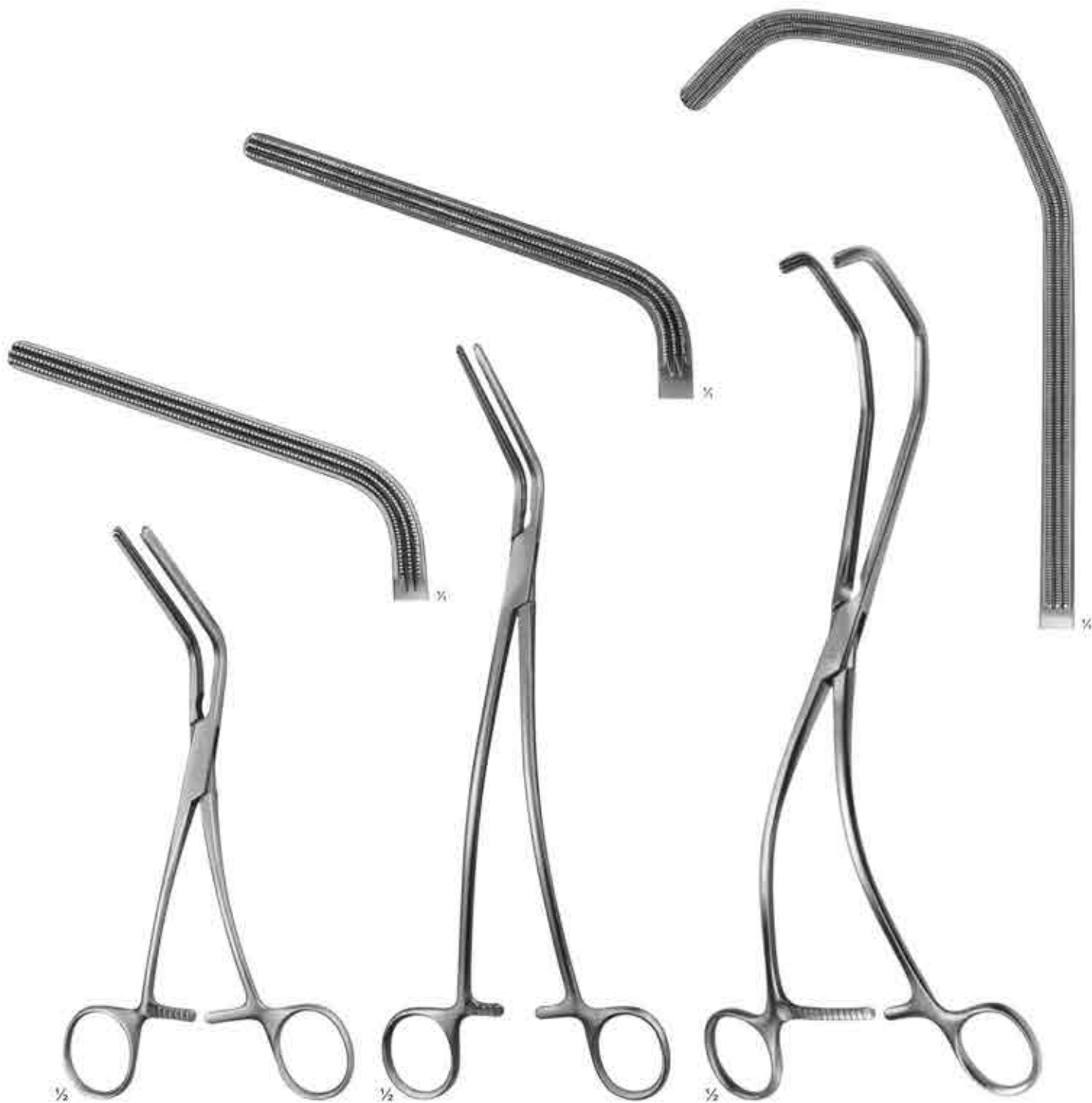

07-122
MORRIS
175 mm

07-123
DE BAKEY
(MORRIS modif.)
240 mm

07-124
KERSTING
270 mm

Nasal Specula



08-101
Martin
13 cm / 5 1/8"



08-102
SIMS
160 mm



08-103
Tieck-Halle
13 cm / 5 1/8"



08-104
Killian

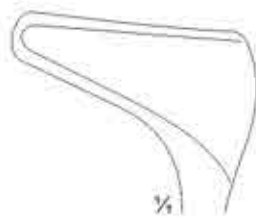

Fig. 1
14 cm 5 4/8"
35 mm

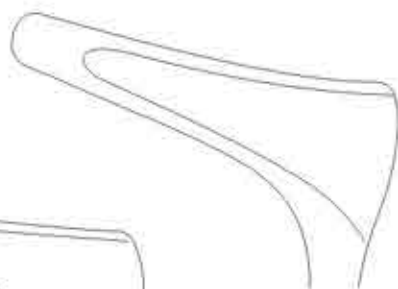

Fig. 2
14,5 cm / 5 4/8"
50 mm

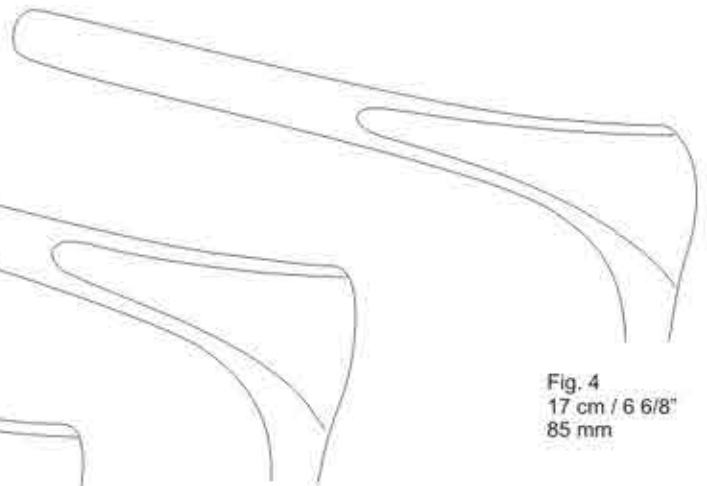

Fig. 3
16 cm / 6 2/8"
75 mm

Fig. 4
17 cm / 6 6/8"
85 mm

Nasal Specula



08-105
Cottle

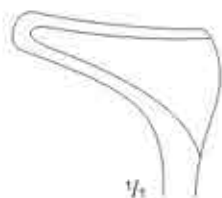

Fig. 1
13,5 cm / 5 3/8"
35 mm

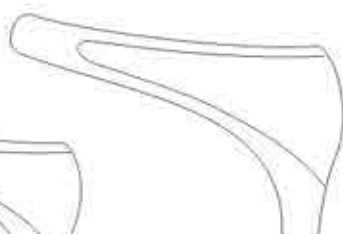

Fig. 2
14 cm / 5 4/8"
50 mm

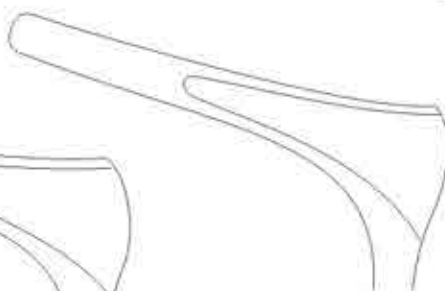

Fig. 3
16 cm / 6 2/8"
75 mm

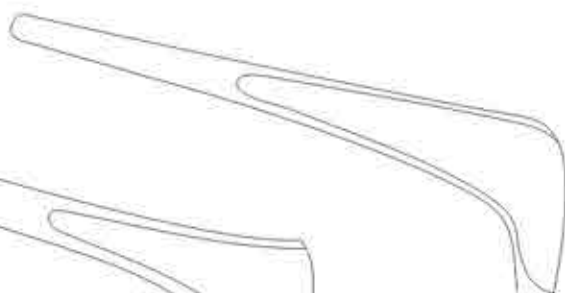

Fig. 4
16 cm / 6 2/8"
85 mm



08-106
Goldsmith (Thudichum)
6,5 cm / 2 4/8"



Fig. 1
21,0 x 9,5 mm



Fig. 2
21,0 x 10,5 mm



Fig. 3
21,0 x 11,5 mm



08-107
Mod. Wien 2
13,5 cm / 5 1/8"



Fig. 1
30 mm



08-108
Hartmann-Halle
16 cm / 6 1/8"



Fig. 1
27 mm



Fig. 2
31 mm



Fig. 3
35 mm

Anuscopes-Sphincteroscopes



08-109
IVES-FANSLER
Anuscops
145 mm
Ø24mm



08-110
KELLY
Sphincteroscope
160 mm
Ø21mm



08-111
KELLY
Sphincteroscope
160 mm
Ø27mm

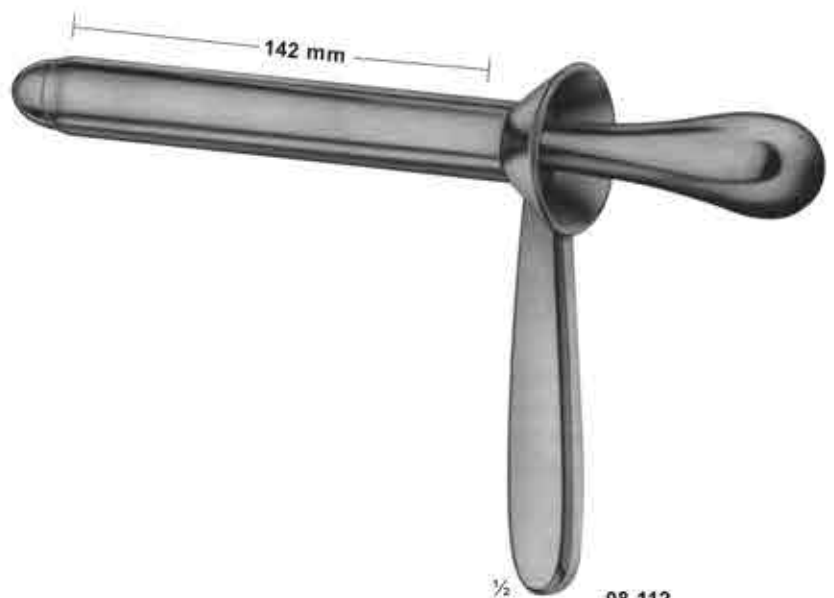

08-112
KELLY
Proctoscope
140 mm
Ø22mm

Haemorrhoidal Forceps

ATRAUMATA

Pressure Clamp

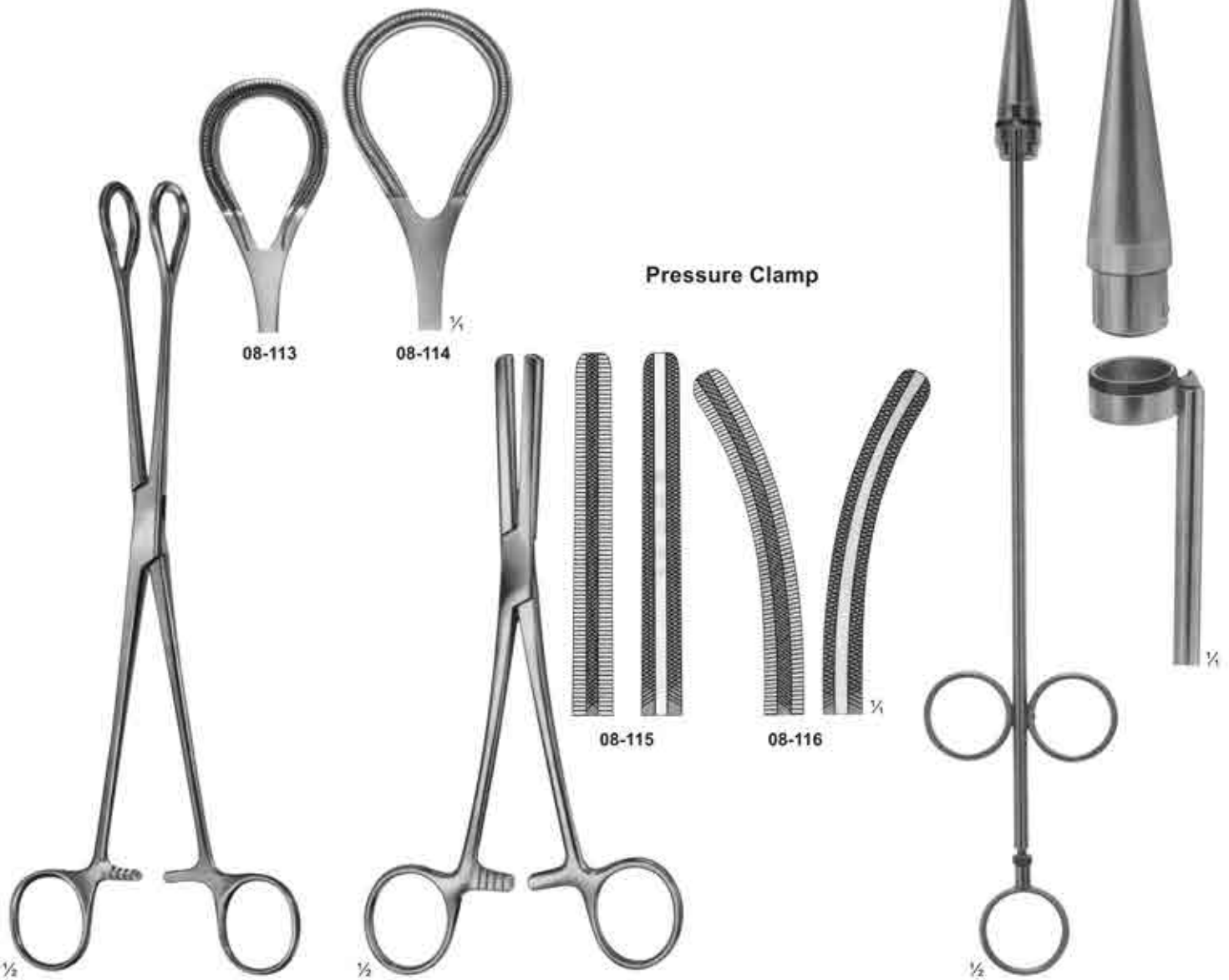

08-113 - 08-114
250 mm
08-114
270 mm

08-115 - 08-116
FERGUSSON
200 mm

08-117
RUDD
Haemorrhoidal ligator
with loading
attachment and 100
ligature rubber rings
315 mm

Gall Duct Forceps



08-118
LOWER
180 mm



08-119
LAHEY (SWEET)
190 mm



08-120
LAHEY
220 mm



08-121
DESJARDINS
Gall duct-and cystic forceps
210 mm



08-122
NISSEN
Gall duct-and cystic forceps
215 mm

Gall Duct Dilators and Gall Stone Scoops

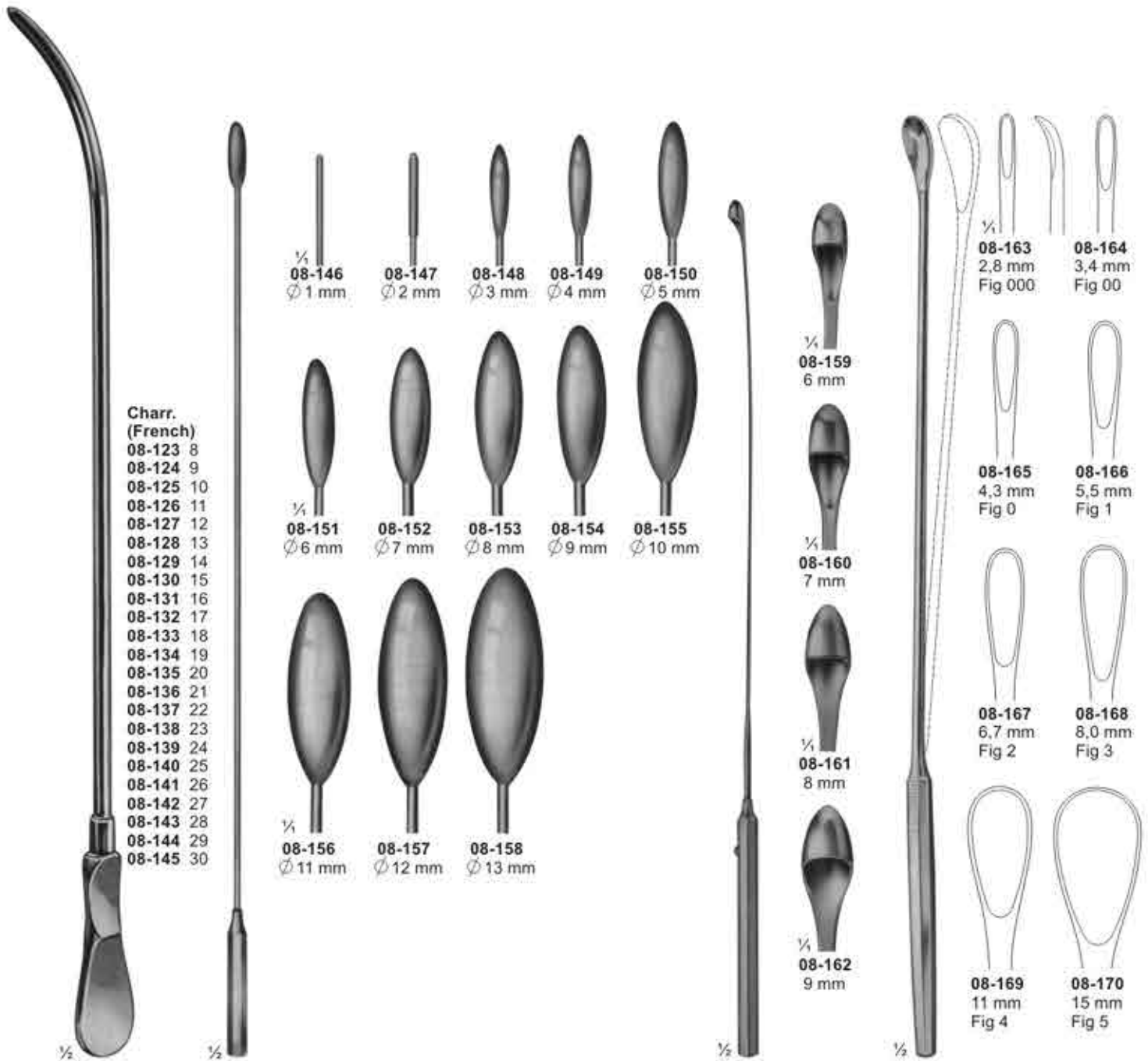

**Charr.
(French)**
 08-123 8
 08-124 9
 08-125 10
 08-126 11
 08-127 12
 08-128 13
 08-129 14
 08-130 15
 08-131 16
 08-132 17
 08-133 18
 08-134 19
 08-135 20
 08-136 21
 08-137 22
 08-138 23
 08-139 24
 08-140 25
 08-141 26
 08-142 27
 08-143 28
 08-144 29
 08-145 30

$\frac{1}{4}$ 08-146 \varnothing 1 mm
 08-147 \varnothing 2 mm
 08-148 \varnothing 3 mm
 08-149 \varnothing 4 mm
 08-150 \varnothing 5 mm

 $\frac{1}{4}$ 08-151 \varnothing 6 mm
 08-152 \varnothing 7 mm
 08-153 \varnothing 8 mm
 08-154 \varnothing 9 mm
 08-155 \varnothing 10 mm

 $\frac{1}{4}$ 08-156 \varnothing 11 mm
 08-157 \varnothing 12 mm
 08-158 \varnothing 13 mm

$\frac{1}{4}$ 08-159 6 mm
 $\frac{1}{4}$ 08-160 7 mm
 $\frac{1}{4}$ 08-161 8 mm
 $\frac{1}{4}$ 08-162 9 mm

 $\frac{1}{4}$ 08-163 2,8 mm Fig 000
 08-164 3,4 mm Fig 00

 08-165 4,3 mm Fig 0
 08-166 5,5 mm Fig 1

 08-167 6,7 mm Fig 2
 08-168 8,0 mm Fig 3

 08-169 11 mm Fig 4
 08-170 15 mm Fig 5

08-123 - 08-145
DITTEL
 Metall bougies and dilating sounds, stiff 345 mm

08-146 - 08-158
BAKES
 Common bile duct dilators, malleable
 08-146 - 08-150 315 mm
 08-151 - 08-158 320 mm

08-159 - 08-162
DESJARDINS
 Probe and catch with flexible schaft 300 mm

08-163 - 08-170
LUER-KOERTE modif
 with malleable shaft 310 mm

Gall Stone Forceps

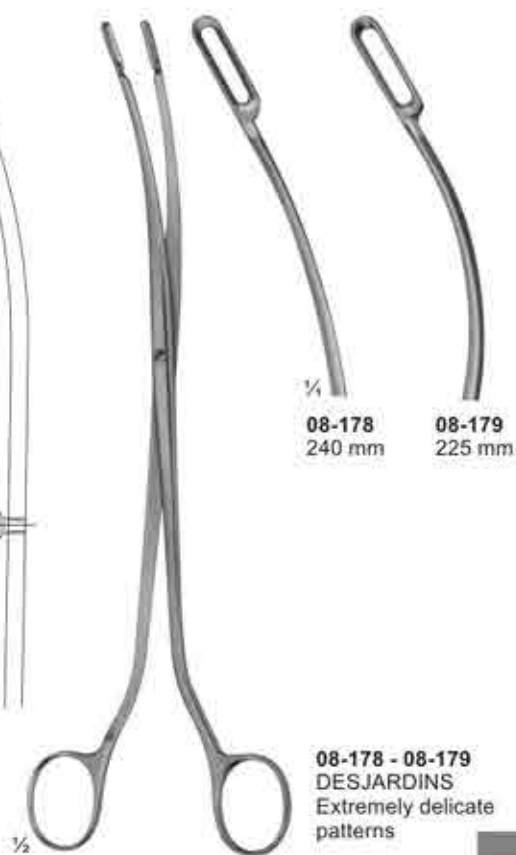
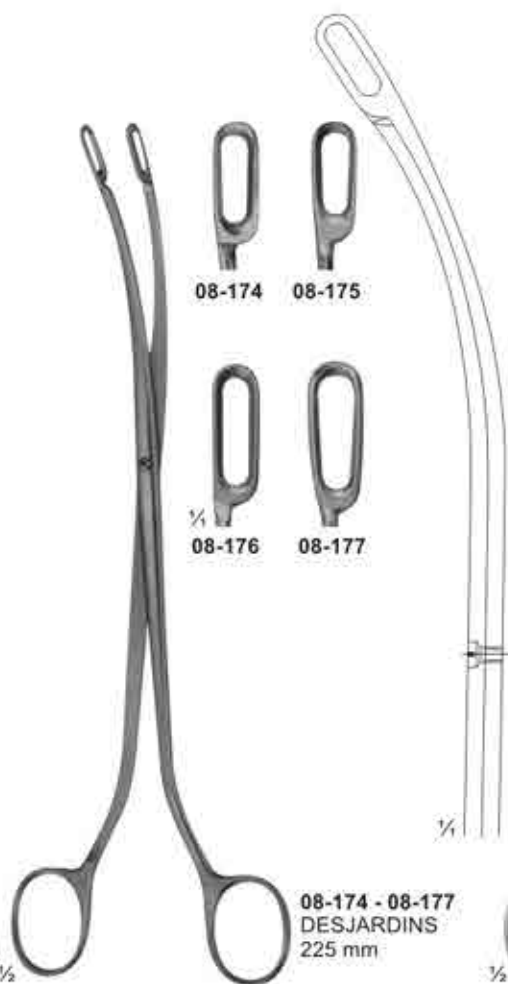
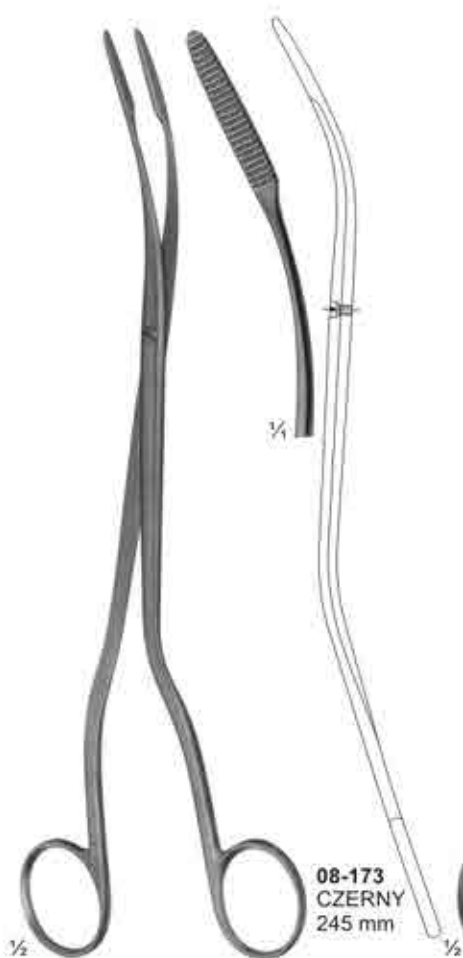
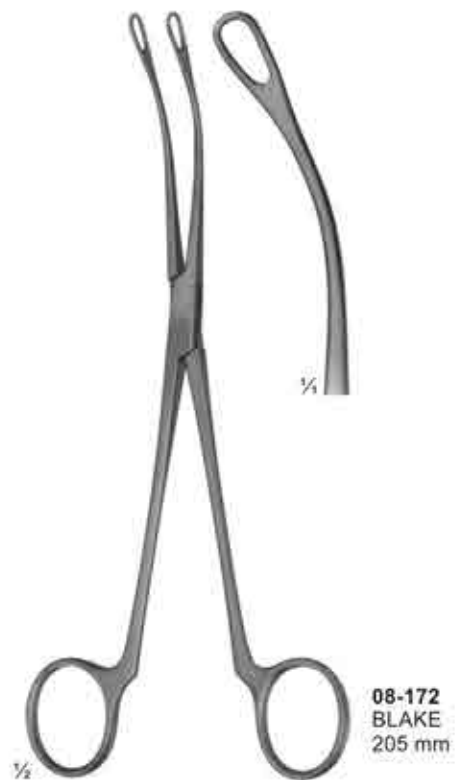

Kidney Clamps

ATRAUMATA

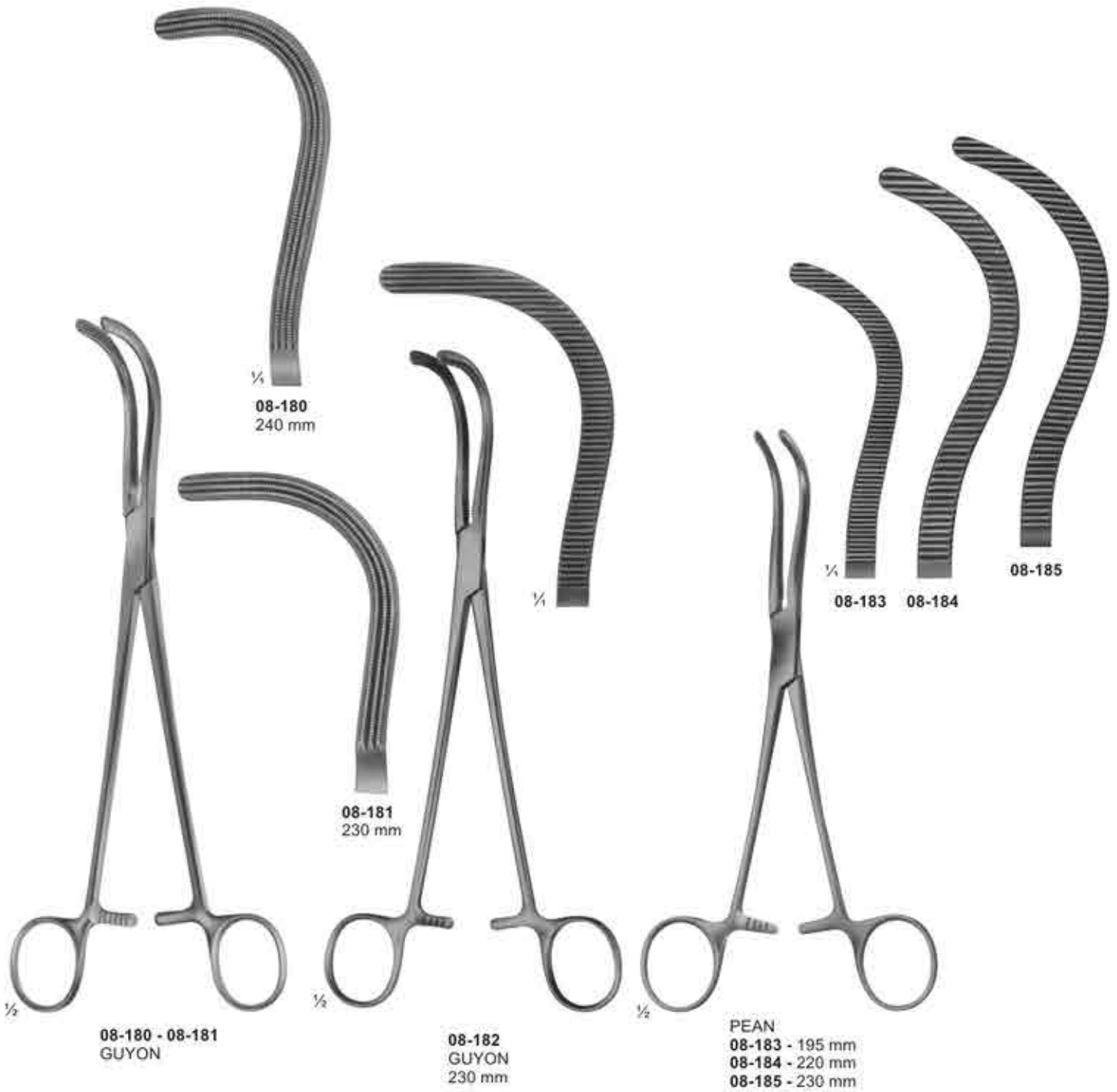

Kidney Stone Forceps



08-186



08-187



08-188



1/2
08-189



08-190



08-191



1/2
08-192



1/2

08-186 - 08-189
RANDALL
225 mm



1/2

08-190 - 08-192
RANDALL
190 mm

Bladder Retractors



09-101
JUDD-MASSON
 Bladder-and suprapubic retractor



09-102
MILLIN
 Center bladder for retro pubic prostatectomy



09-103
MILLIN
 Bladder retractor, complete
 105X45 mm



09-104
LEGUEU
 Bladder retractor
 Center blade
 80 x 31 mm



09-105
KOCHER
 Bladder spatula
 235 mm

Trocars



09-106
KLIMA ROSEGGER
35 X 1,8 mm
Sternal puncture needle



09-107
Universal trocar
with 4 tips.



NELSON



09-108 - 112
Inside diam. Outside diam
09-108 2,2 mm 3,0 mm
09-109 3,0 mm 4,0 mm
09-110 4,0 mm 5,0 mm
09-111 5,0 mm 6,0 mm
09-112 5,5 mm 6,5 mm
for hydrocele and abdominal
puncture

09-113 - 116
Inside diam. Outside diam
09-113 2,2 mm 3,0 mm
09-114 3,0 mm 4,0 mm
09-115 4,0 mm 5,0 mm
09-116 5,0 mm 6,0 mm
for abdominal puncture,
with stop-cock and lateral
drain



09-117 - 118
Inside diam. Outside diam
09-117 6,5 mm 8,0 mm
09-118 9,0 mm 10,0 mm
Empyema trocar
BUELEU



09-119 - 122
Inside diam. Outside diam
09-119 3,0 mm 4,0 mm
09-120 3,6 mm 4,6 mm
09-121 4,3 mm 5,3 mm
09-122 5,0 mm 6,0 mm
Gall bladder trocars. OCHSNER



09-123
PIERCE
Antrum trocar
4,0 mm



09-124
COAKLEY
Antrum trocar
3,0 mm

Vaginal Specula



10-101
COLLIN
for children
53 x 10 mm

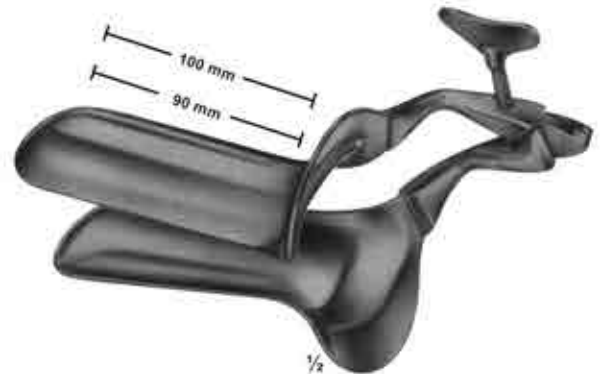

10-102 - 105
COLLIN

10-102	100/90mm	28 mm
10-103	100/90mm	32 mm
10-104	105/95mm	35 mm
10-105	115/105mm	40 mm
Total length/working length		width



10-106
COLLIN
for virgins
95/85 x 18 mm



10-107
CUSCO
for virgins
75 x 17 mm



10-108
CUSCO
for virgins
75 x 17 mm



Swiss patterns
features: long and narrow

10-109 - 111
CUSCO

10-109	92X23-25 mm
10-110	100x25-27 mm
10-111	110x27-30 mm

Vaginal Specula- Sets, upper and lower blades



10-112 - 114
GRAVE
10-112 75X20 mm
10-113 95X30 mm
10-114 105X33 mm

½



10-115 - 116
PEDERSON
10-115 100X22 mm
10-116 120X25 mm

½



10-117 - 118
BRIESKY
10-117 72X25 mm / 77X30 mm 140 mm
10-118 75X30 mm / 92X38 mm 170 mm

½



½

10-119
SIMS
70 X 26 mm / 75 X 30 mm
75 X 30 mm / 80 X 35 mm
80 X 36 mm / 90 X 40 mm
175 mm



½

10-120 - 122
SEIDL
10-120 80X8 mm
10-121 80X10 mm
10-122 90X14 mm
For children and infants
170 mm



½

10-123
KRISTELLER
70X15 mm, (170 mm)
For children



½

10-124 - 10-126
KRISTELLER
10-124 70X27 mm
10-125 75X30 mm
10-126 90X36 mm
175 mm

Vaginal Specula- upper and lower blades



10-127 - 131
KRISTELLER
 10-127 110X18 mm
 10-128 110X20 mm
 10-129 110X27 mm
 10-130 110X30 mm
 10-131 110X36 mm
 220 mm

10-132 - 10-135
KRISTELLER
 Upper blades

10-136 - 10-139
KRISTELLER
 Lower blades

Vaginal Specula



Vaginal Retractors



1/2
10-154
JOLL (FRIEDMAN)
155 mm



1/2
10-155
RICHTER
170 mm



1/2
10-156
GELPI
135 mm



1/2
10-157
GELPI
175 mm

Uterine Dilators



¼

11-101 - 143
HEGAR
with very conical point
185 mm

11-101	1	mm	11-123	23	mm
11-102	2	mm	11-124	24	mm
11-103	3	mm	11-125	25	mm
11-104	4	mm	11-126	26	mm
11-105	5	mm	11-127	1	½mm
11-106	6	mm	11-128	2	½mm
11-107	7	mm	11-129	3	½mm
11-108	8	mm	11-130	4	½mm
11-109	9	mm	11-131	5	½mm
11-110	10	mm	11-132	6	½mm
11-111	11	mm	11-133	7	½mm
11-112	12	mm	11-134	8	½mm
11-113	13	mm	11-135	9	½mm
11-114	14	mm	11-136	10	½mm
11-115	15	mm	11-137	11	½mm
11-116	16	mm	11-138	12	½mm
11-117	17	mm	11-139	13	½mm
11-118	18	mm	11-140	14	½mm
11-119	19	mm	11-141	15	½mm
11-120	20	mm	11-142	16	½mm
11-121	21	mm	11-143	17	½mm
11-122	22	mm			



¼

11-144 - 152
HEGAR
205 mm

11-144	1+2	mm
11-145	3+4	mm
11-146	5+6	mm
11-147	7+8	mm
11-148	9+10	mm
11-149	11+12	mm
11-150	13+14	mm
11-151	15+16	mm
11-152	17+18	mm



¼

11-153
HEGAR
Uterine dilator set, in canvas
roll with 8 dilators.

Uterine Probes



11-154
MAYO
malleable
330 mm



11-155
SIMS
malleable
330 mm



11-156
MARTIN
330 mm



11-157
SIMPSON
malleable
silver-plated
290 mm



11-158
BRAUN
Uterine
depressor
270 mm



11-159
Cotton
applicator
270 mm

Uterine Dressing Forceps



11-160
PELKMANN
260 mm



11-161
PELKMANN
260 mm



11-162
BOZEMANN
250 mm



11-163
BOZEMANN
255 mm

Jaws with longitudinal groove

Polypus-and Ovum Forceps

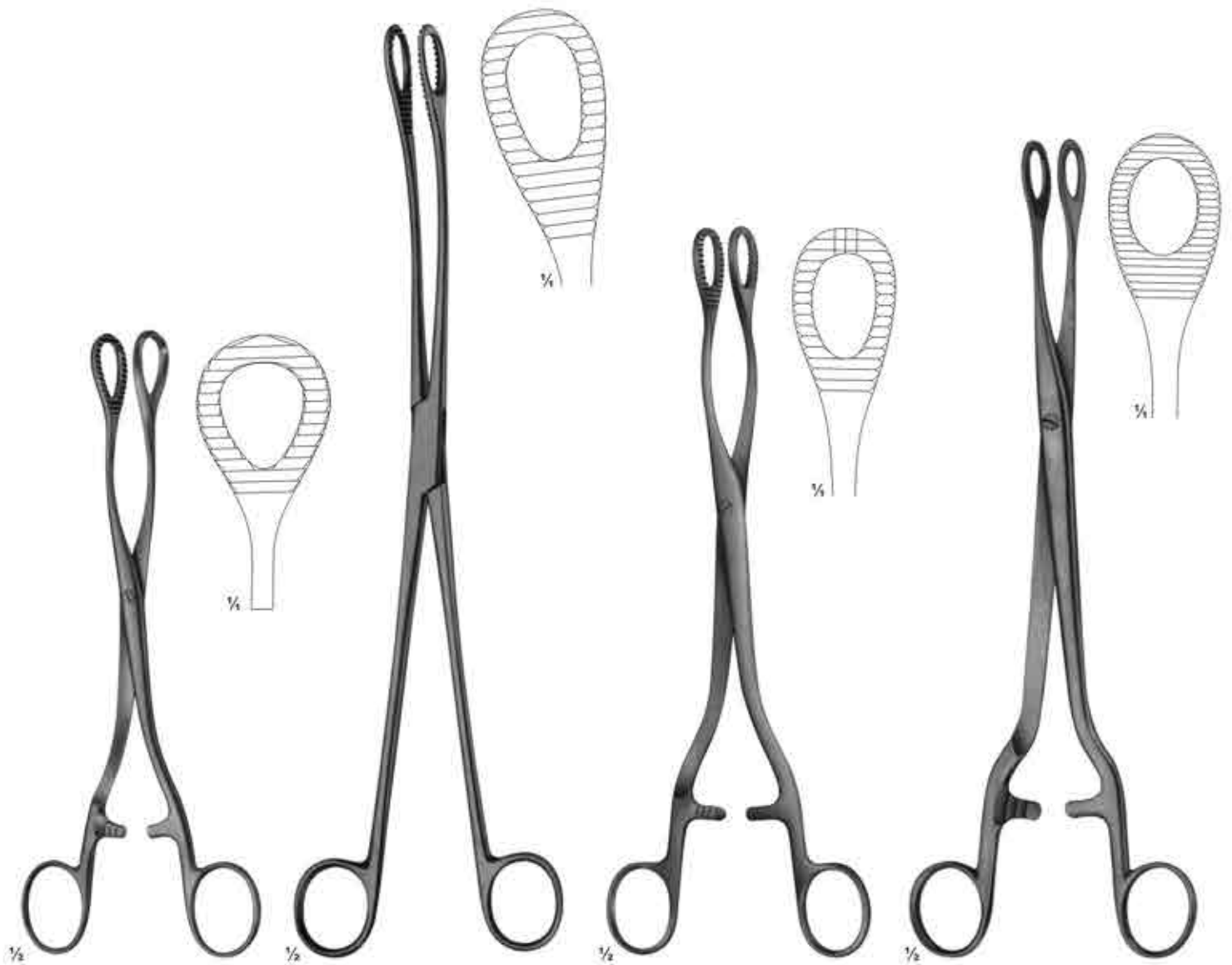

11-164
HEYWOOD-SMITH
200 mm

11-165
KELLY
320 mm

11-166
HEYWOOD-SMITH
250 mm

11-167
NOTO
280 mm

Ear Curettes



12-101
Langenbeck
13 cm / 5 1/8"

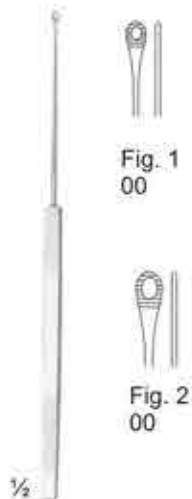

12-102
Shapleigh
15 cm / 5 1/8"

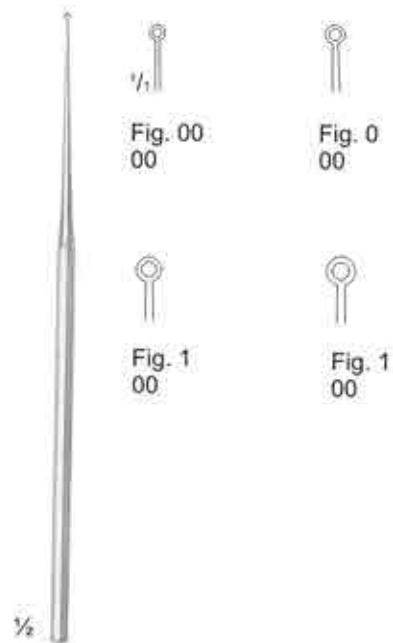

12-103
Buck
17cm / 6 6/8"



12-104
Buck
15 cm / 6 6/8"

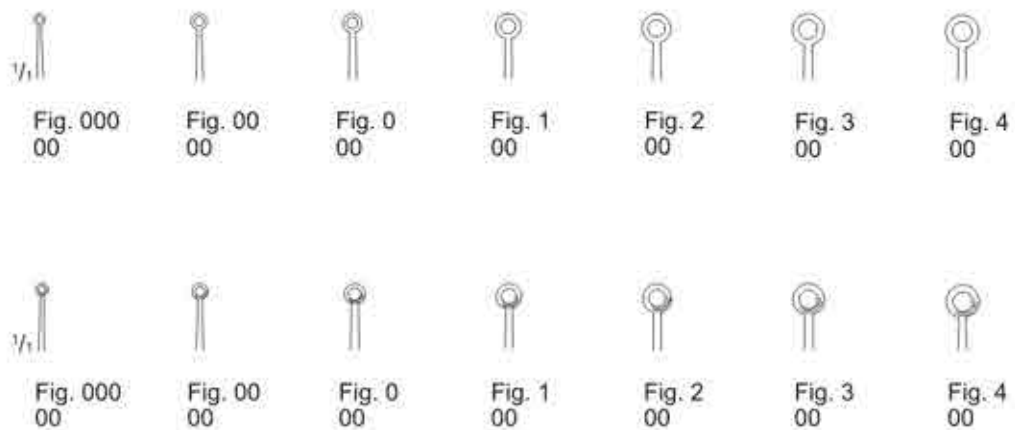

Biopsy Curettes

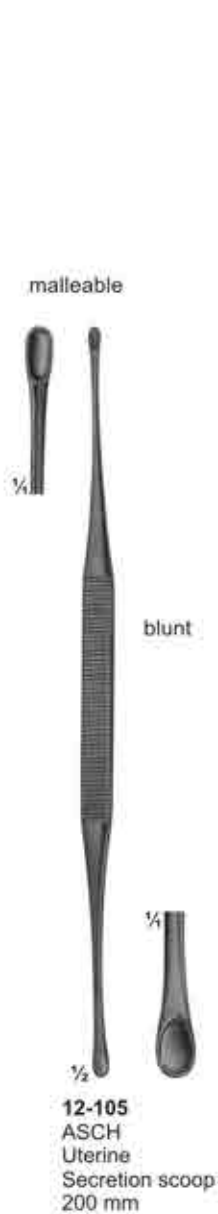

Ear Polypus Forceps



12-109
Hartmann-Wullstein
shaft length
85 mm

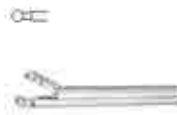

12-110
Hartmann-Wullstein
shaft length
85 mm



12-111
Hartmann
shaft length
85 mm



12-112
Hartmann
shaft length
85 mm

12-113
14 cm / 5 4/8"
shaft length
140 mm



12-109 - 12-119



12-114
Hartmann-Herzfeil
2,0 mm
shaft length
85mm



12-115
Hartmann
3 mm
shaft length
85mm



12-116
shaft length
85mm



12-117
Hartmann-Hoffmar
2,0 mm
85mm

12-118
2,5 mm
85 mm

12-119
3,0 mm
85 mm

Biopsy forceps for rectum

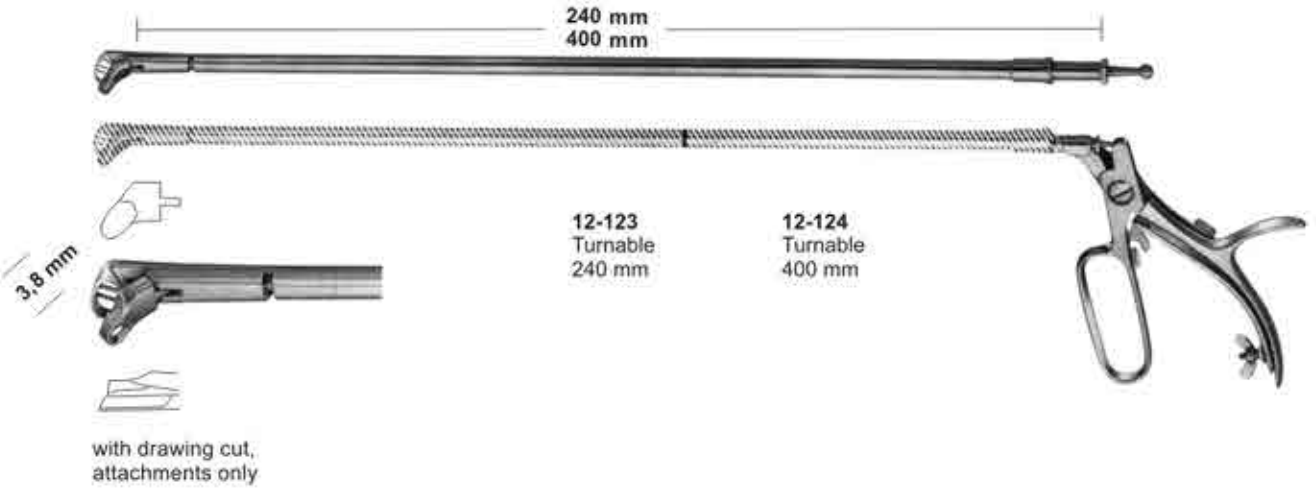
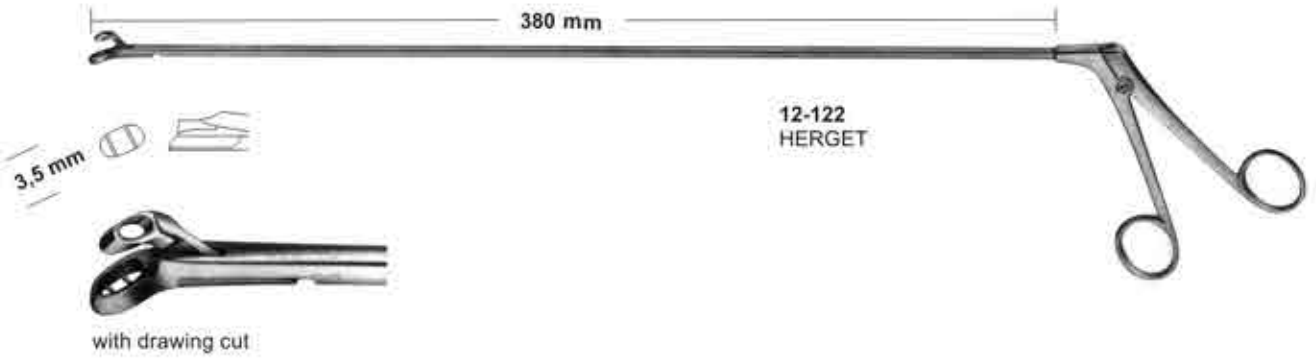
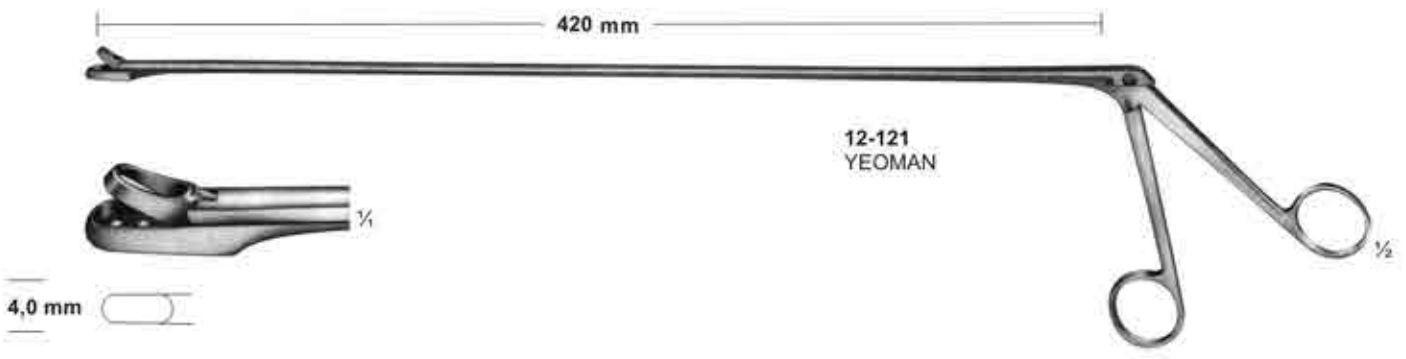
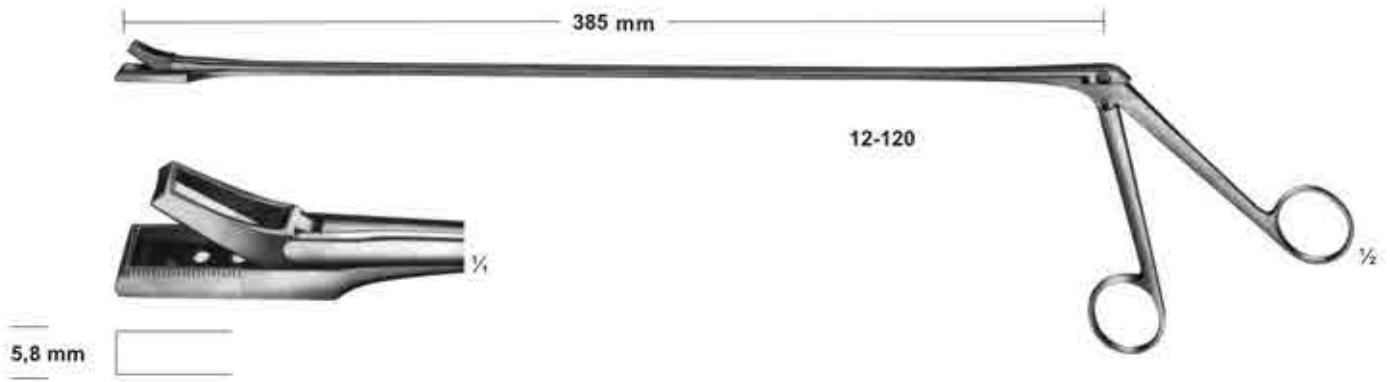

Biopsy Forceps

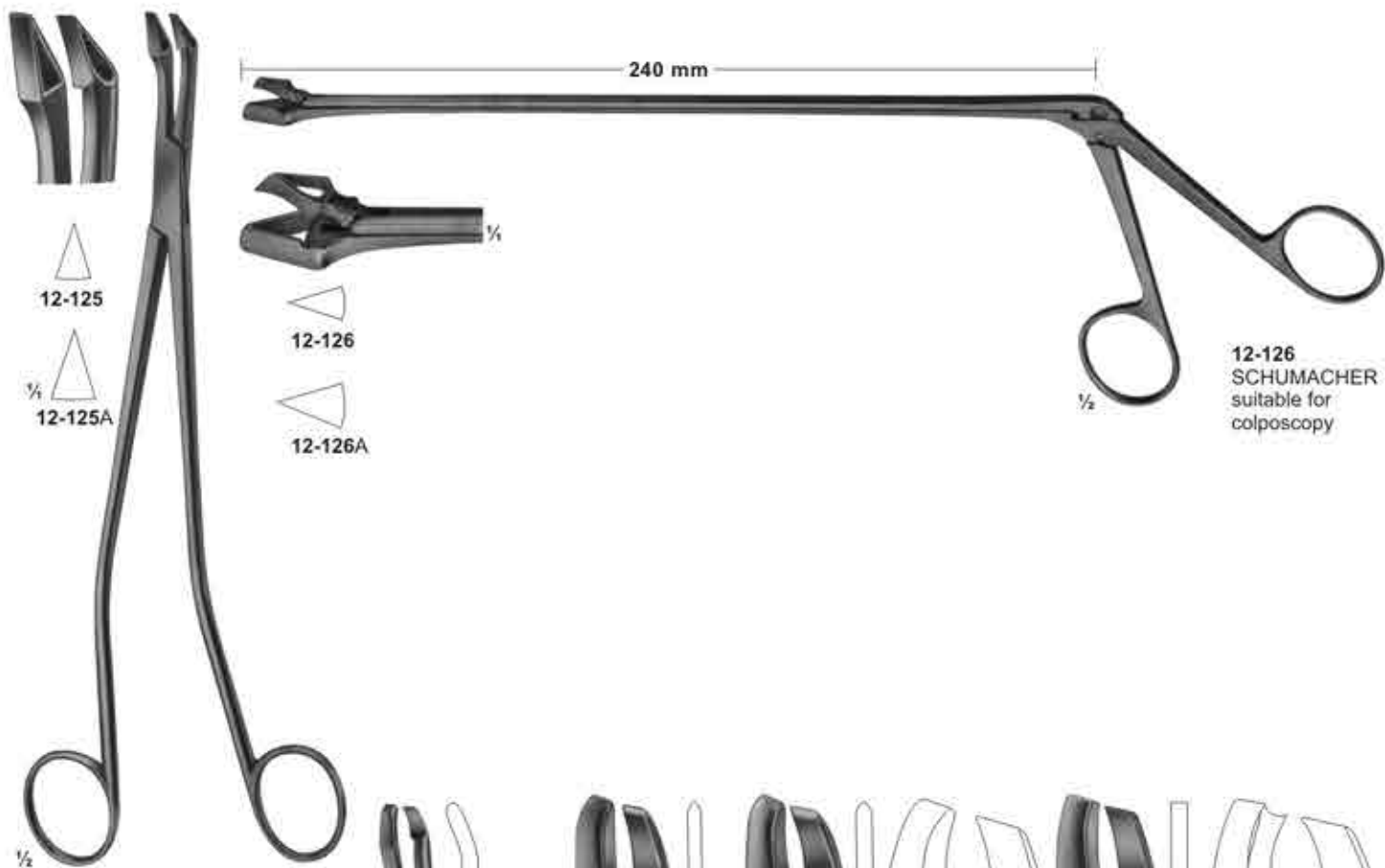

12-125

12-125A

240 mm

1/4

12-126

12-126A

1/2

12-126
SCHUMACHER
suitable for
colposcopy

1/2
12-125
SCHUMACHER
240mm

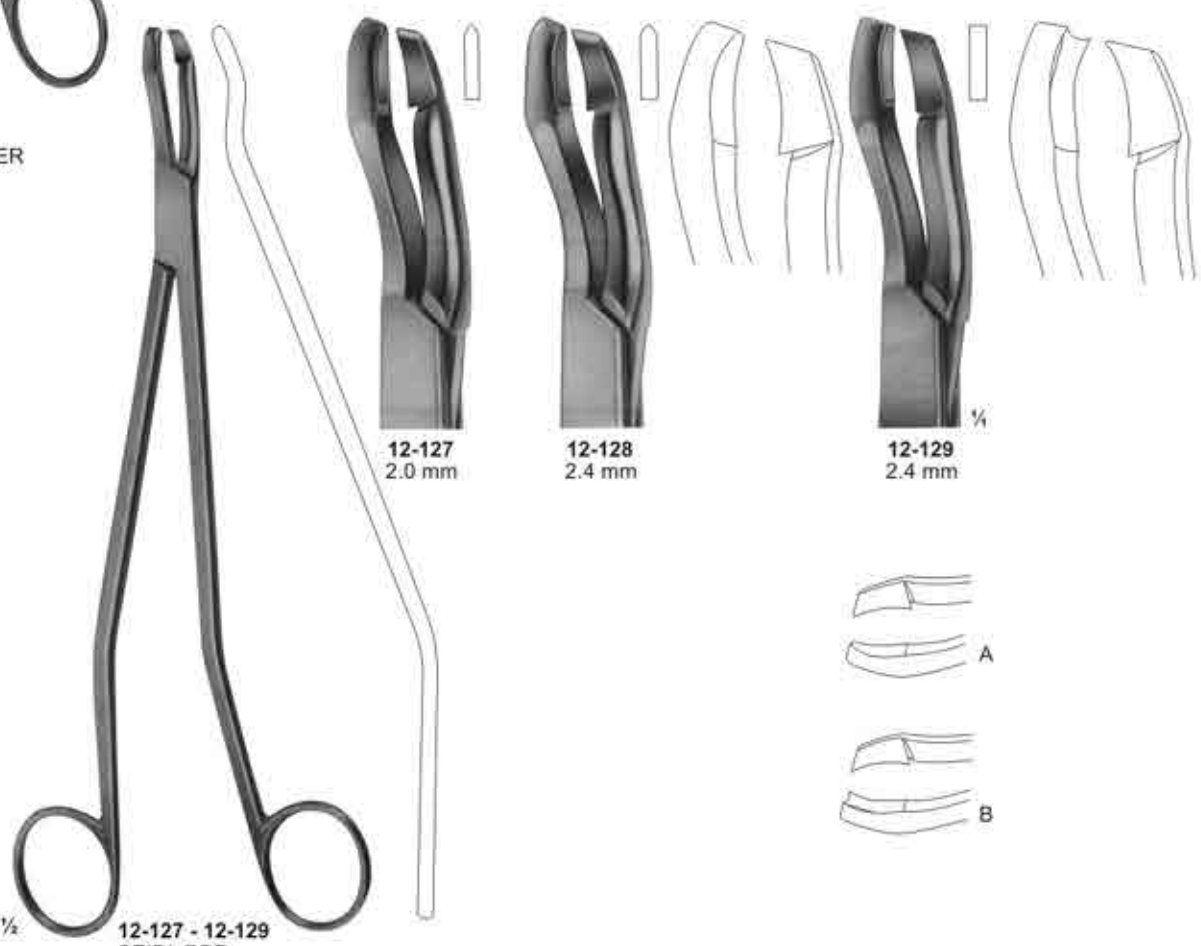

12-127
2.0 mm

12-128
2.4 mm

12-129
2.4 mm

1/2
12-127 - 12-129
SEIDL DBP
Biopsy forceps, bayonet shaped
for portio, vagina and vulva
240mm

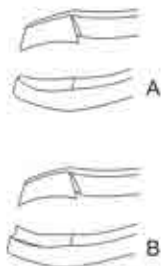

Biopsy Forceps

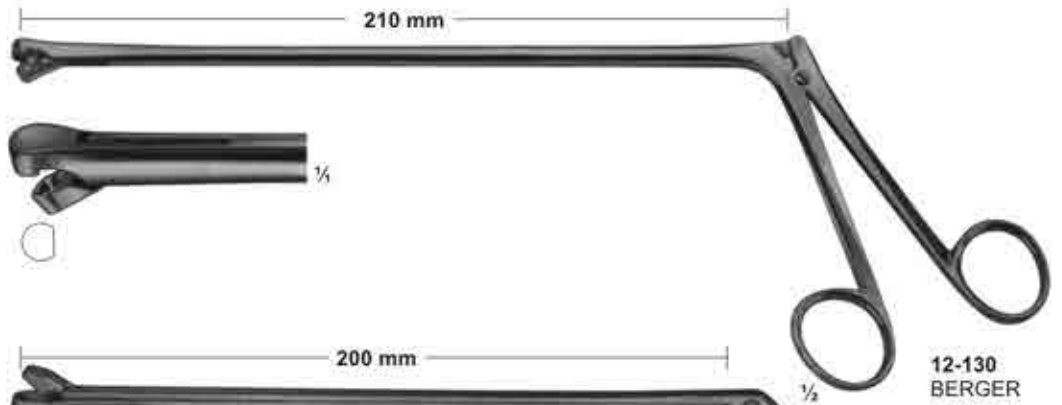

12-130 BERGER

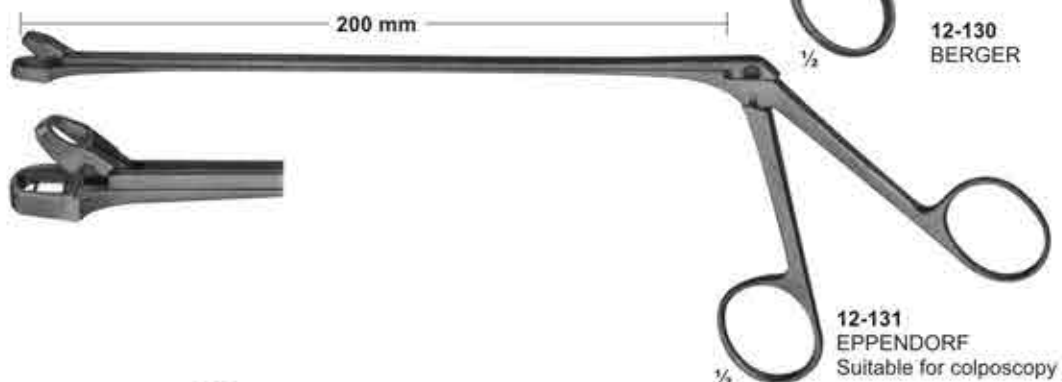

12-131 EPPENDORF
Suitable for colposcopy

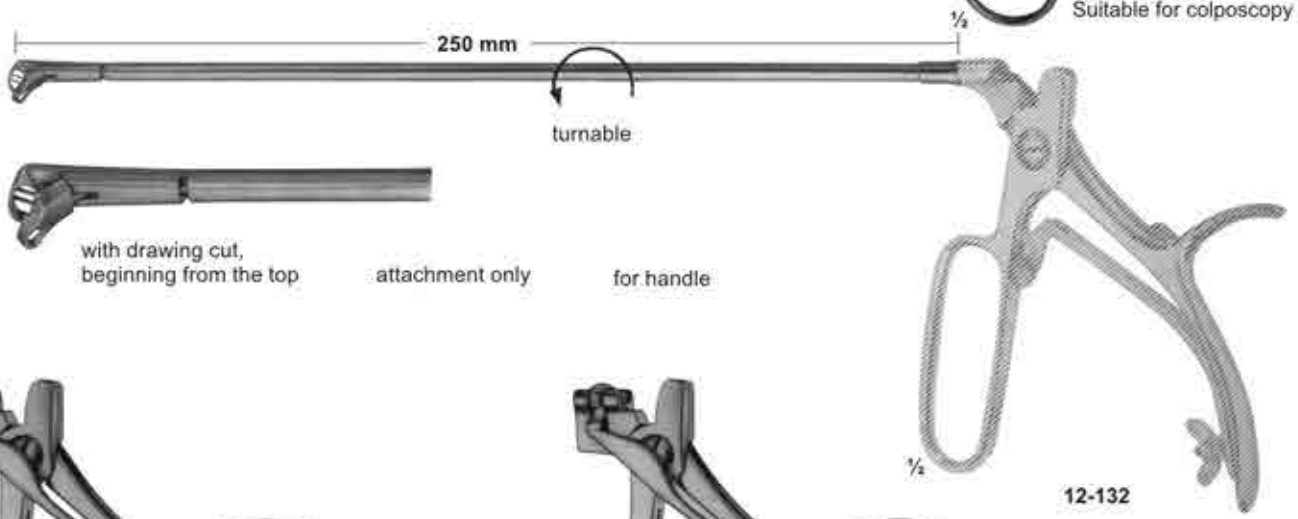

with drawing cut, beginning from the top attachment only for handle

12-132



12-133 AESCULAP
140 mm



12-134 HUBER
140 mm



Extension cannulae

12-135 BRUENINGS 200 mm Length
12-136 BRUENINGS 250 mm Length



⊕ ⊕
12-137 12-137A
12-137 KRAUSE (Biopsy tip)



⊕
12-138 SCHEINMANN (Biopsy tip)



△ 12-139 SCHUMACHER (Biopsy tip)
with drawing cut

Uterine Scoops



12-140
SIMON
240 mm

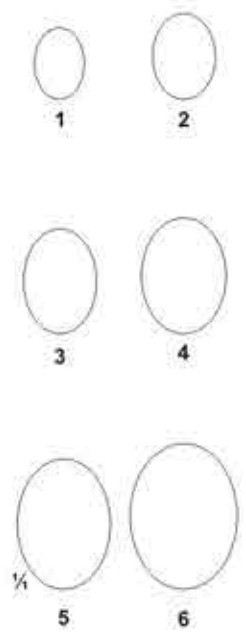

12-141
SCHROEDER
310 mm

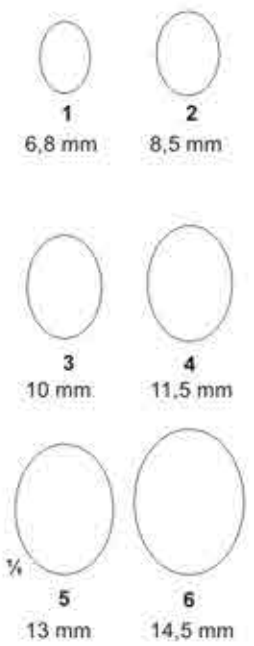

12-142
RECAMIER
300 mm

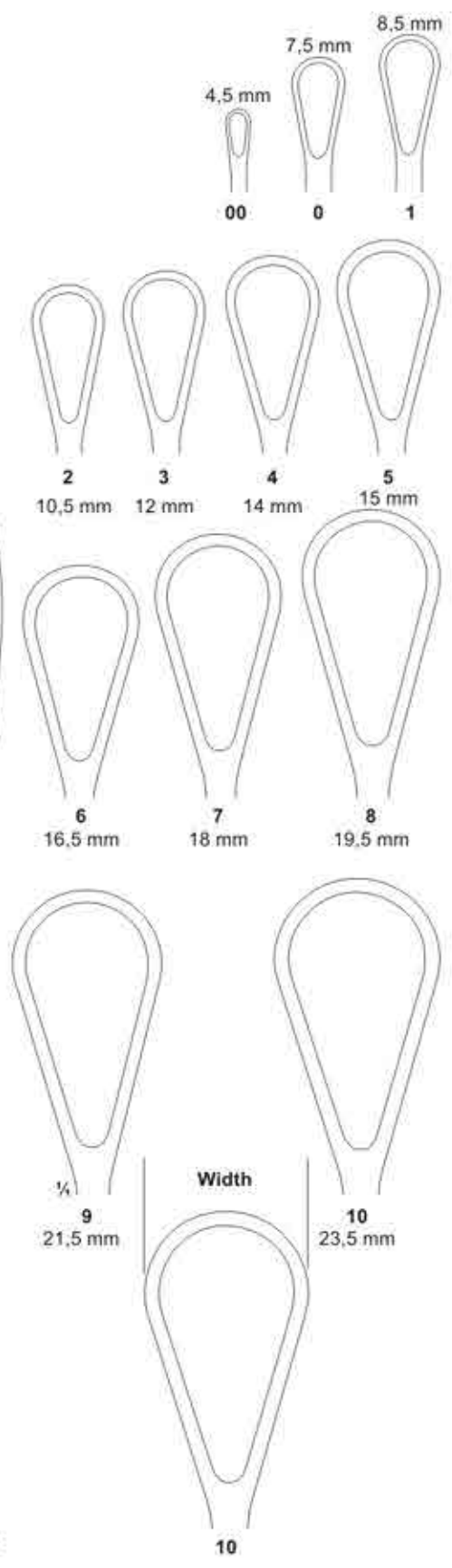

Obstetrical Forceps



13-101
NAEGELE
355 mm



13-102
NAEGELE
400 mm



13-103
SIMPSON-BRAUN
305mm

Obstetrics- Placenta and Ovum Forceps

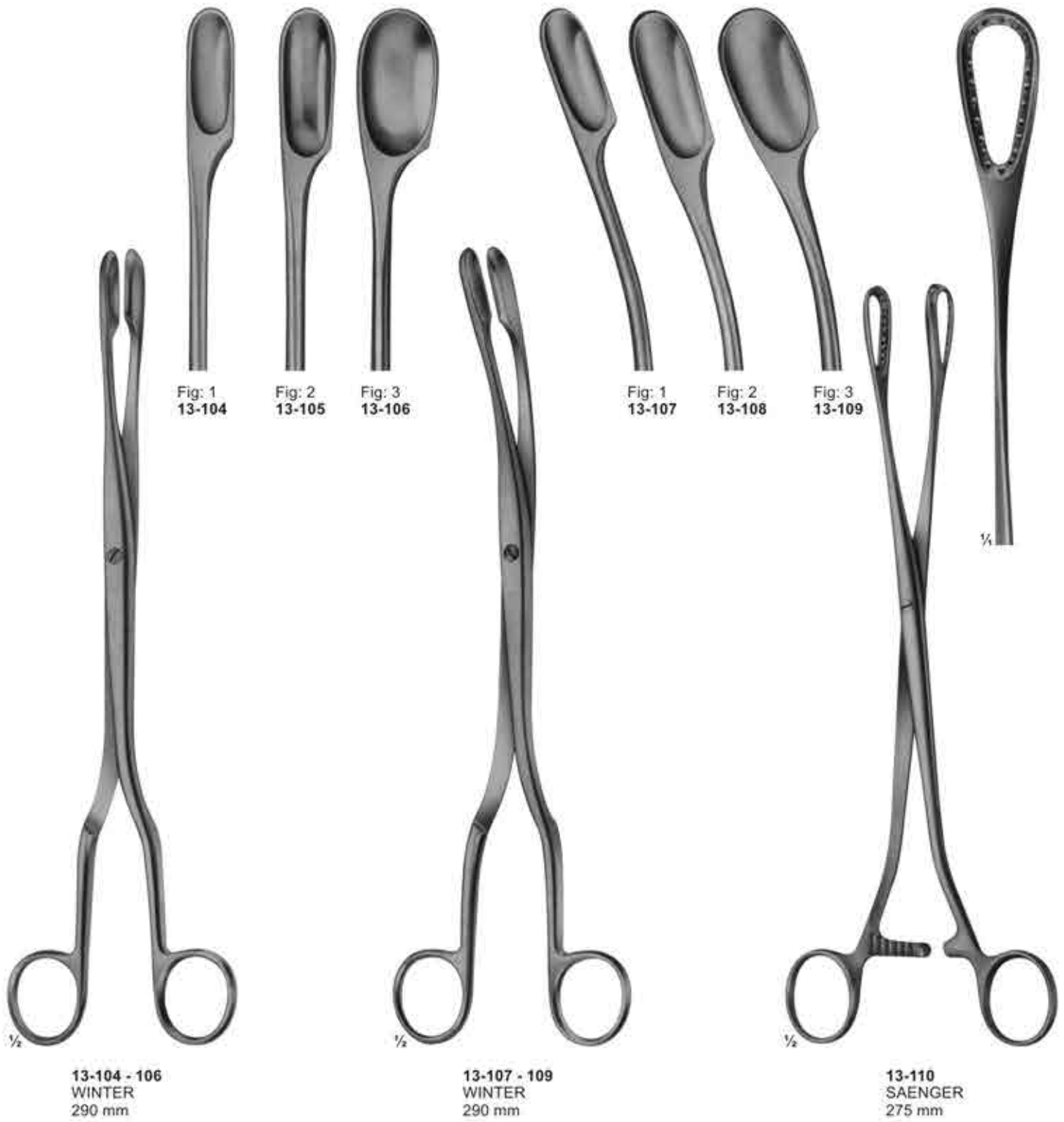

Tongue and Tracheal Hooks and Dilators

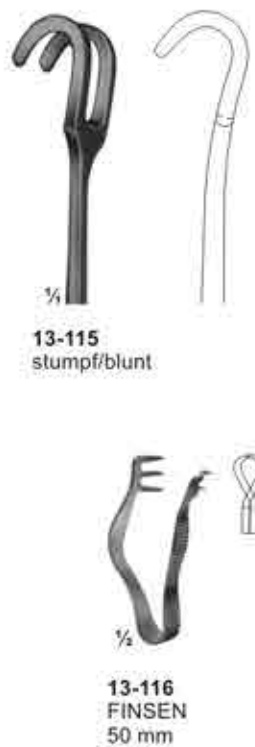
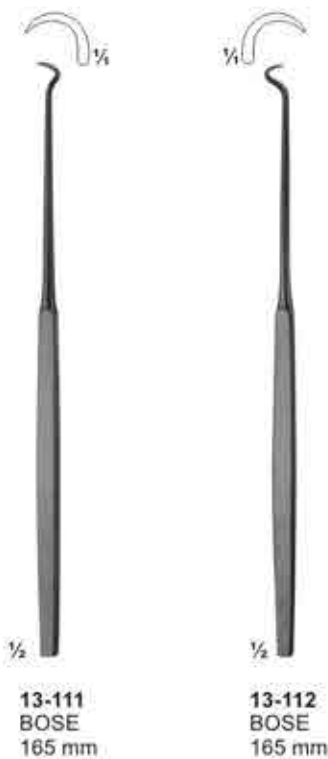

Vascular Spatulas

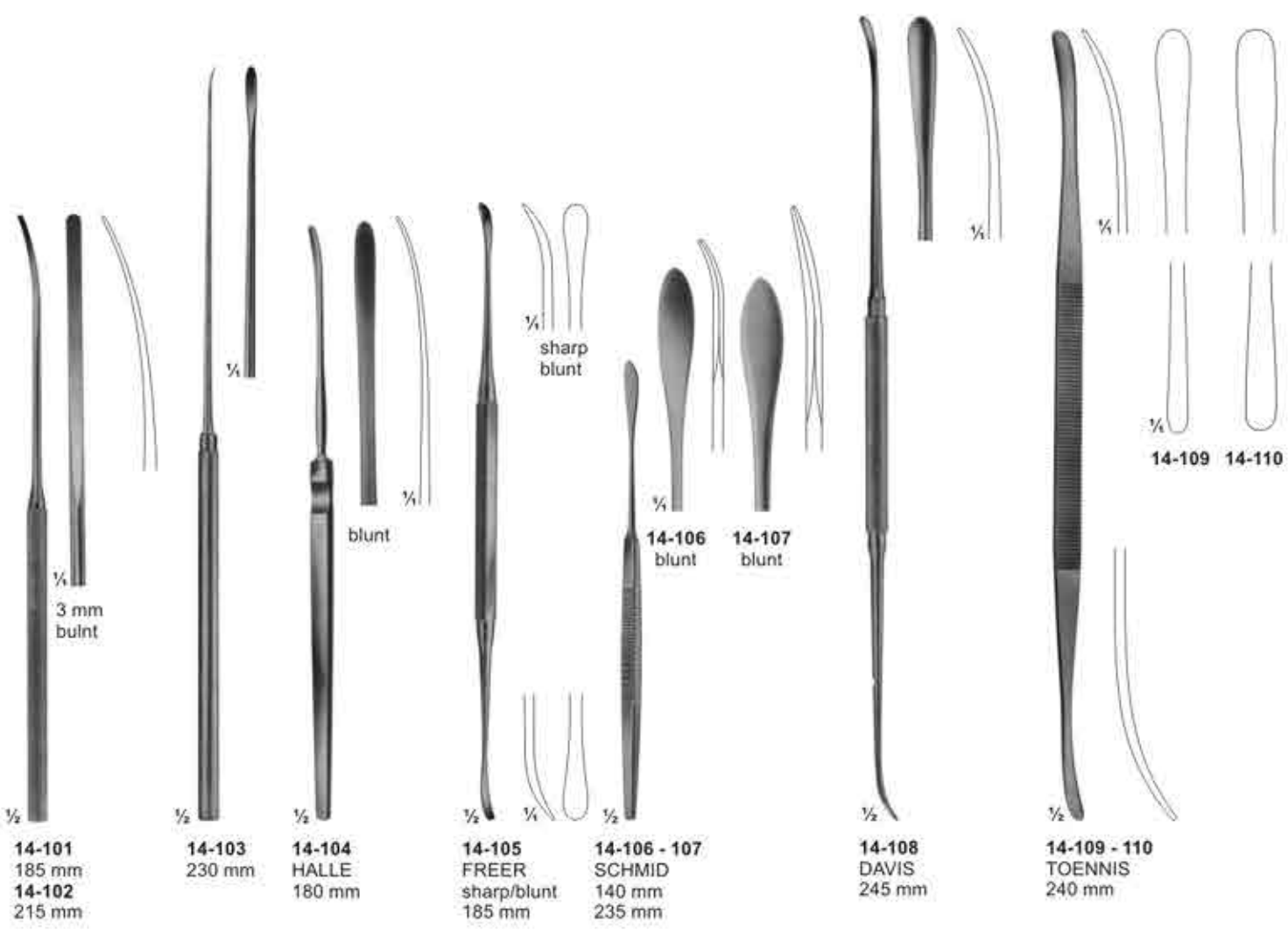

14-101
185 mm
14-102
215 mm

14-103
230 mm

14-104
HALLE
180 mm

14-105
FREER
sharp/blunt
185 mm

14-106 - 107
SCHMID
140 mm
235 mm

14-108
DAVIS
245 mm

14-109 - 110
TOENNIS
240 mm

ATRAUMATA Forceps

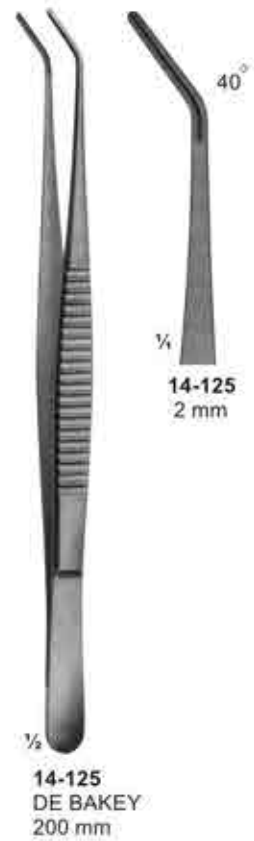
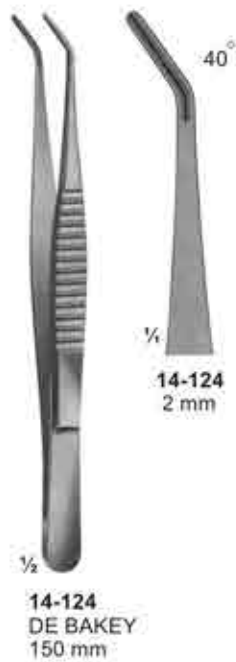
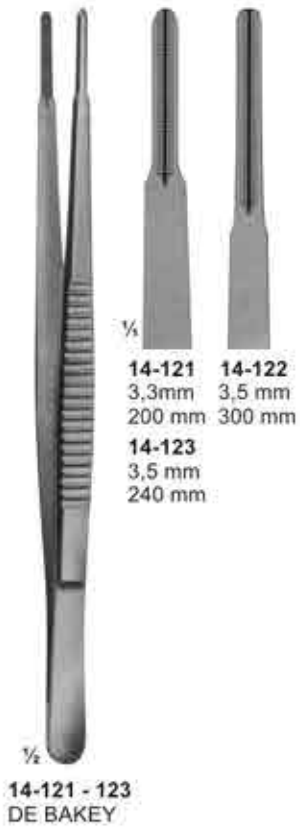
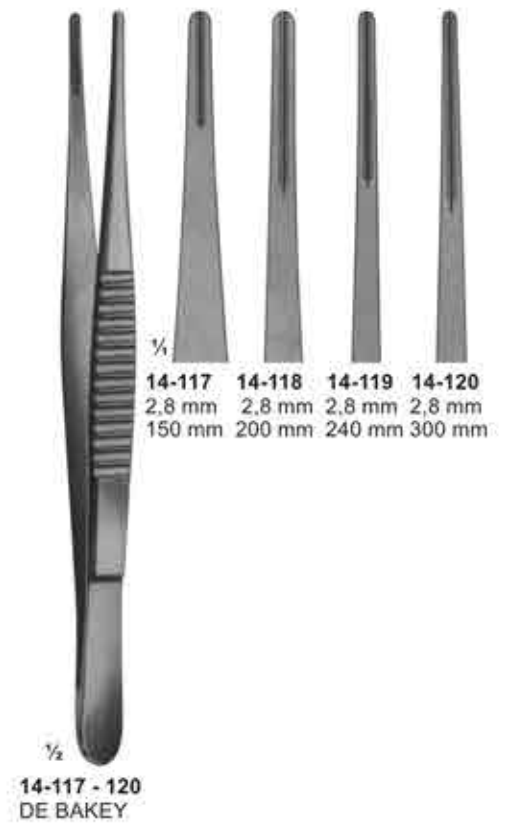
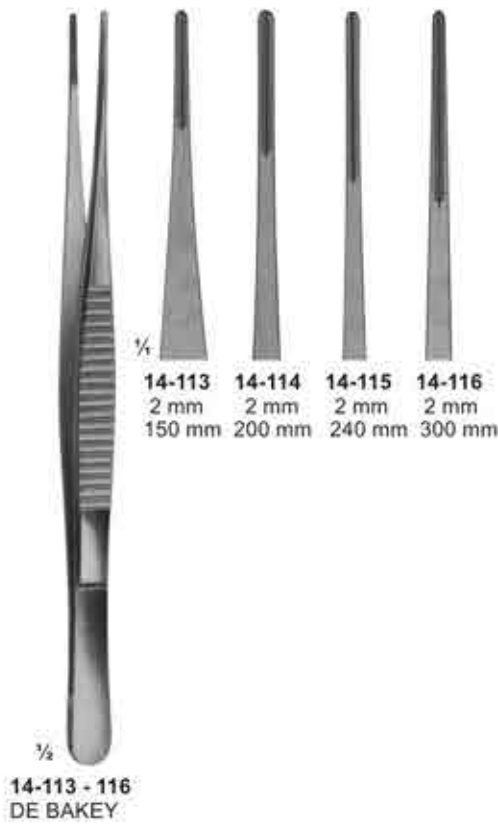
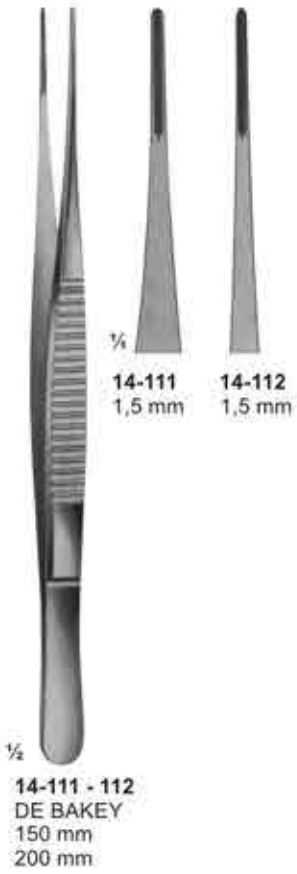

ATRAUMATA

Anastomosis- and Multi- Purpose- Clamps- Pediatric types

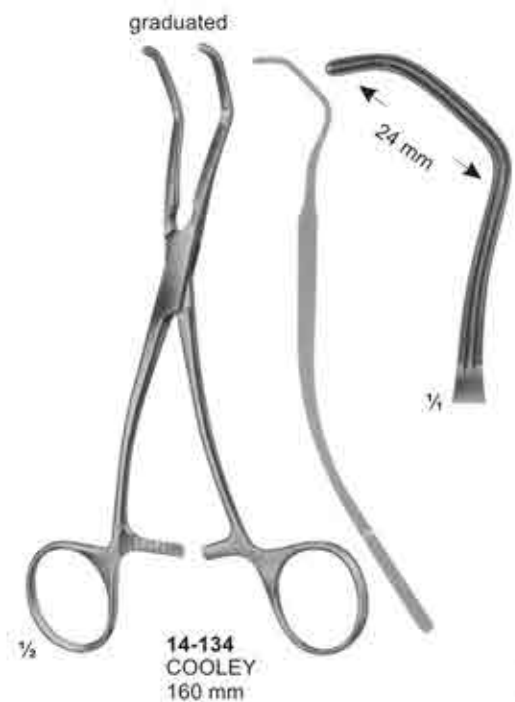
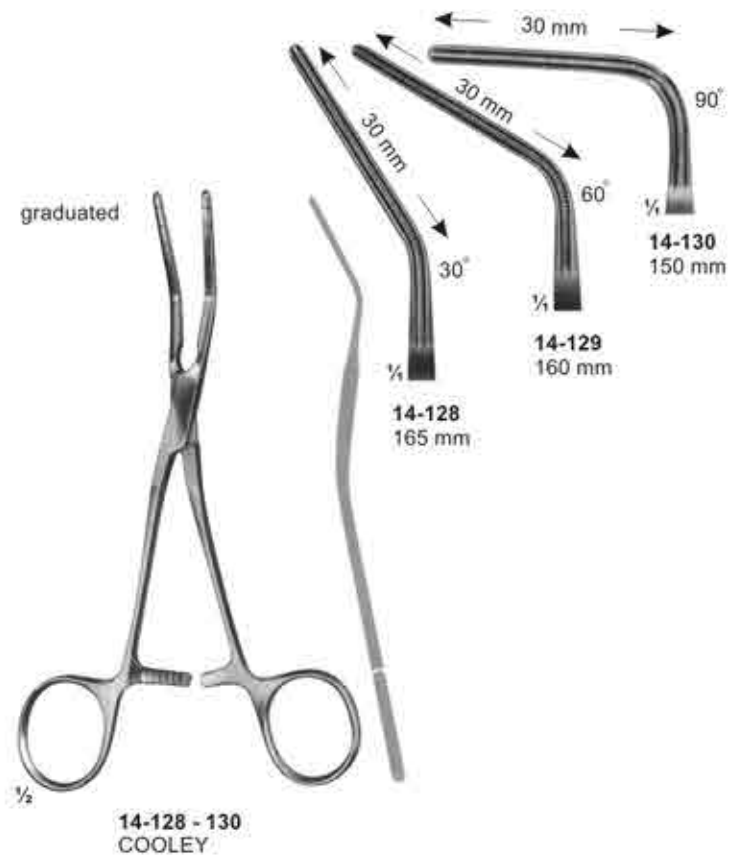
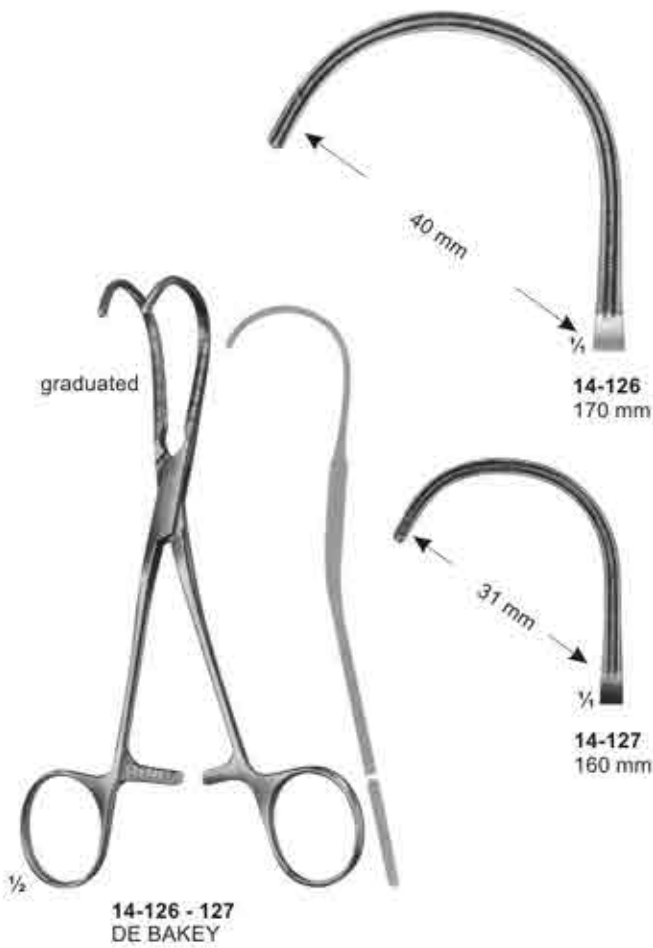

ATRAUMATA

Coarctation Clamps, Patent-Ductus & Peripheral-Vascular Clamps



14-135 - 137
DE BAKEY



14-135 41 mm 205 mm	14-136 65 mm 225 mm	14-137 80 mm 240 mm
----------------------------------	----------------------------------	----------------------------------



14-138 - 140
DE BAKEY



14-138 41 mm 200 mm	14-139 65 mm 225 mm	14-140 80 mm 240 mm
----------------------------------	----------------------------------	----------------------------------



14-141
DE BAKEY
210 mm



1/4
51 mm



14-142
DE BAKEY
210 mm



15°
1/4
51 mm



14-143
DE BAKEY
160 mm



1/4
56 mm

Aorta- Anastomosis Clamps



L
14-144
WEBER
260 mm



R
14-145
WEBER
260 mm

Multi- Purpose-Clamps



14-146 - 149
DE BAKEY

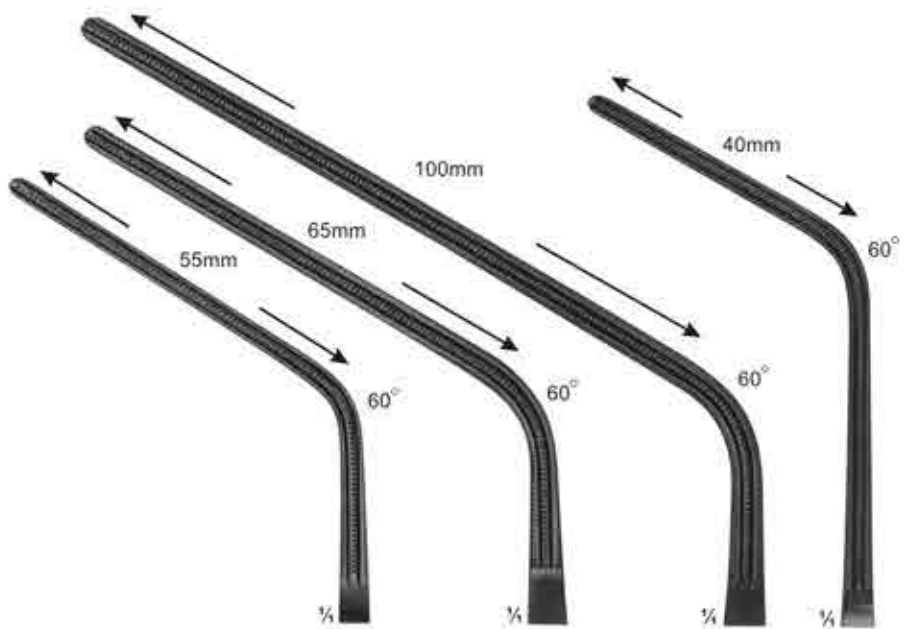

14-146 14-147 14-148 14-149

Total Length:	230 mm	280 mm	305 mm	240 mm
Length of jaws:	85 mm	100 mm	135 mm	93 mm



14-150 - 153
DE BAKEY

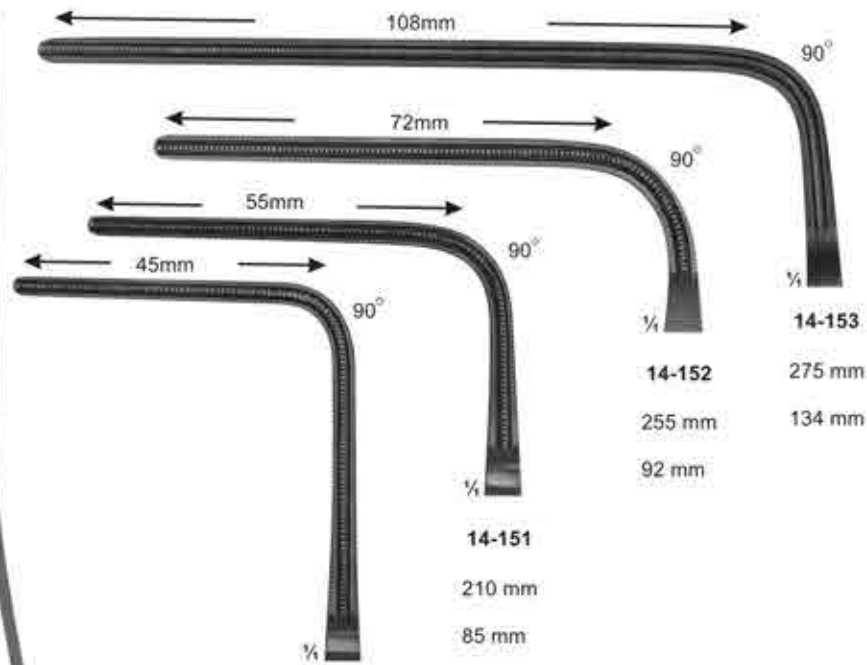

14-150 14-151 14-152 14-153

Total Length:	225 mm	275 mm	255 mm	134 mm
Length of jaws:	93 mm	85 mm	92 mm	

Sternum Instruments and Rib Shears



14-154
SCHUMACHER
Sternum shears
210 mm



14-155
LEBSCHKE
Sternum chisel
200 mm



14-156
230 mm



14-157
COLLIN
195 mm



14-158
GLUCK
190 mm



14-159
BETHUNE
340 mm



14-160
BRUNNER
Universal pattern
340 mm



14-161
GIERTZ-STILLE
250 mm

Rib Spreaders



14-162
FINOCHIETTO
Blades
18X21 mm

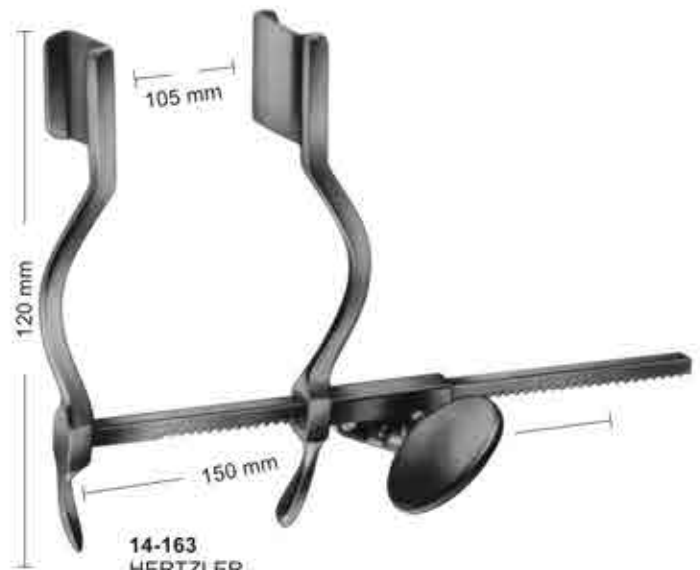

14-163
HERTZLER
Blades
20X25 mm

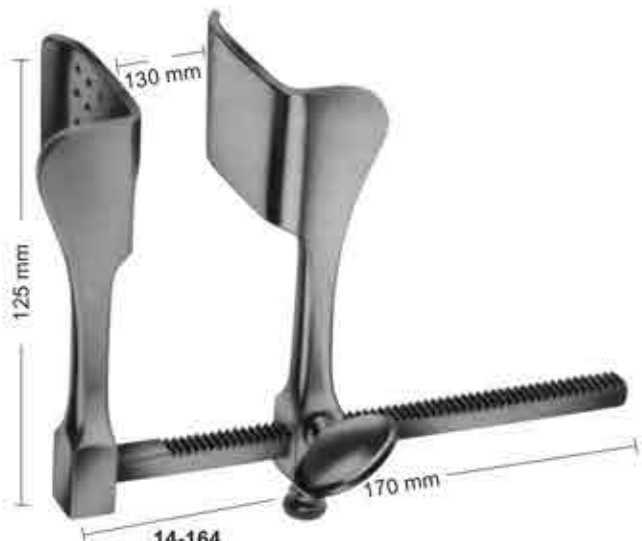

14-164
TUFFIER
Blades
43X53 mm

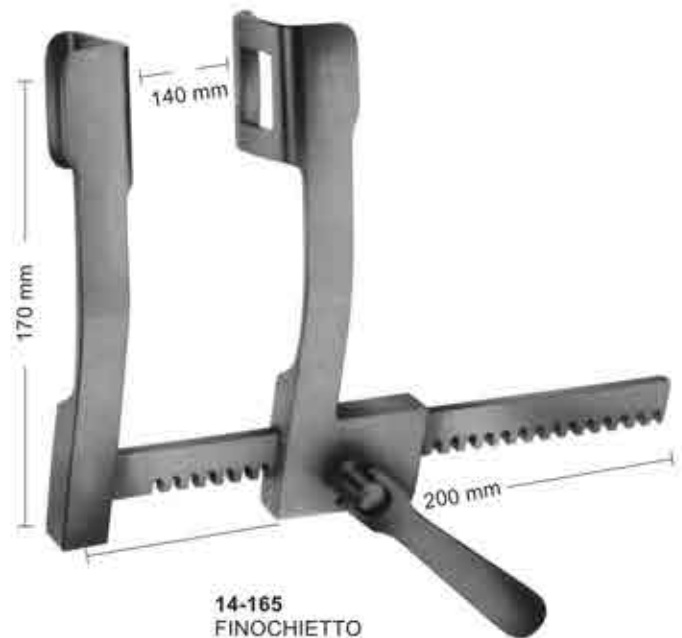

14-165
FINOCHIETTO
Blades
36X45 mm

Rib Spreaders-and Contractors



14-166
SELLORS
Rib spreader-and contractor
with swivel blades
200 mm



14-167
BAILEY
150 mm



14-168
for children

14-169
for adults

14-168 - 169
BAILEY
200 mm

Punches

130° upwards cutting

15-101
1 mm



KERRISON - JACOBY

FERRIS-SMITH-KERRISON

15-102
2 mm



15-103
3 mm



15-104
4 mm



15-105
5 mm

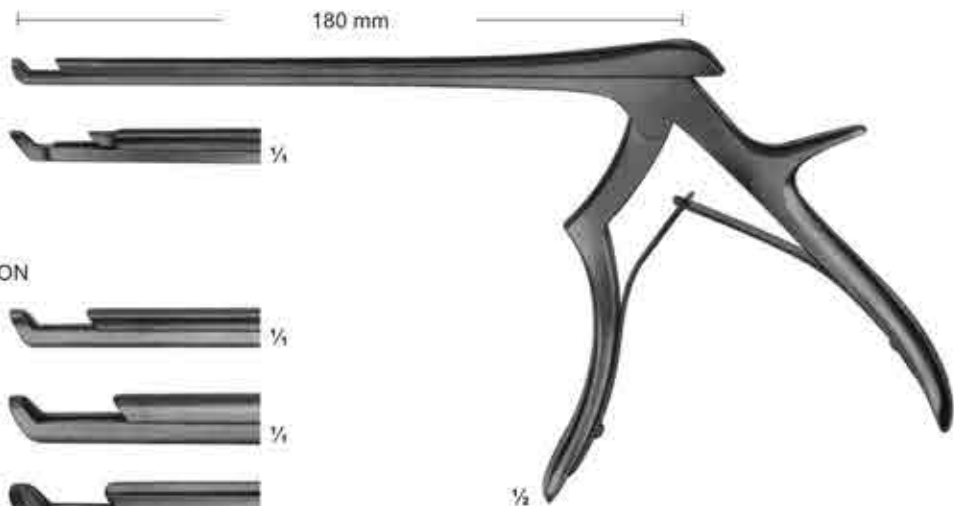

15-101 - 105

90° upwards cutting

KERRISON - JACOBY

15-106
1 mm



15-107
2 mm



FERRIS-SMITH-KERRISON

15-108
3 mm



15-109
4 mm



15-110
5 mm

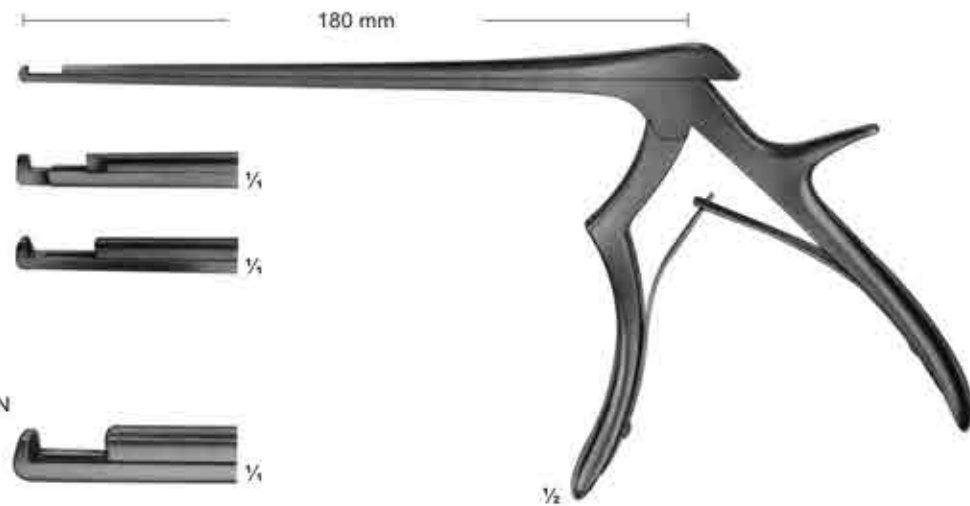

15-106 - 110

Punches

90° upwards cutting

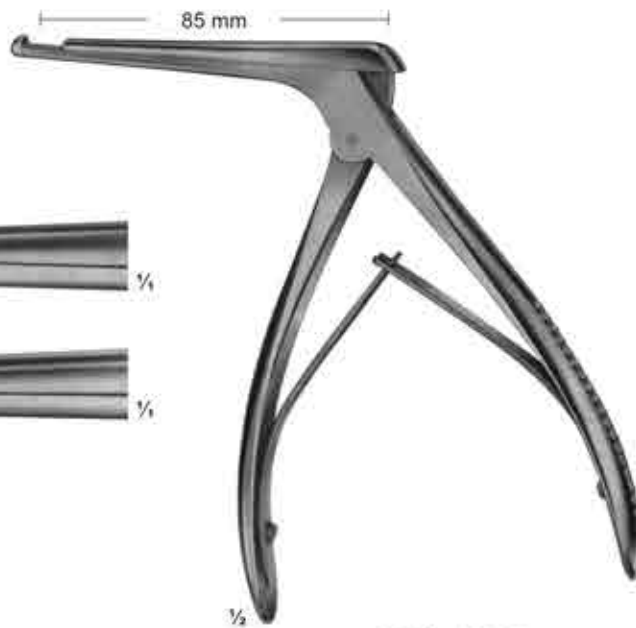

15-111
4 mm



15-112
5 mm



15-111 - 15-112
KERRISON

90° upwards cutting

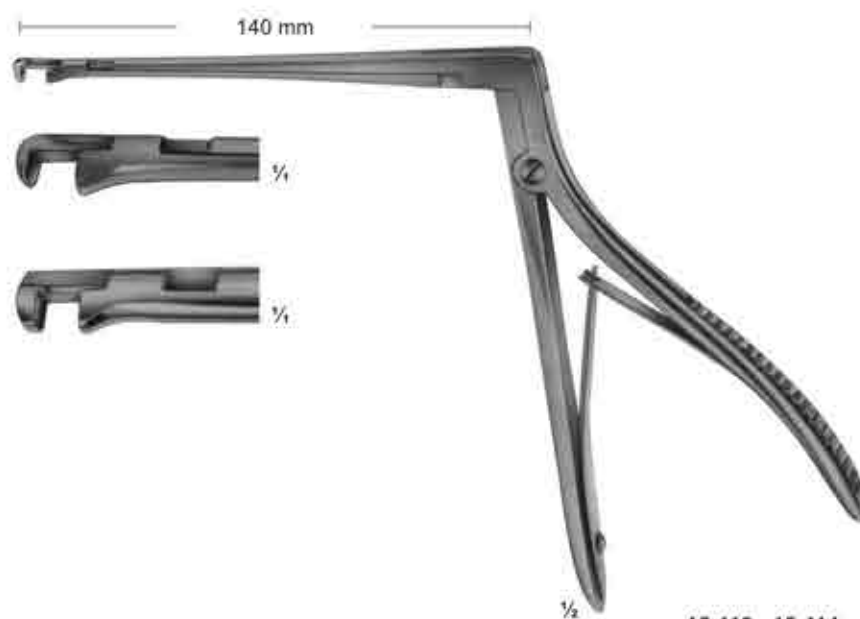

15-113
3,3 mm



15-114
4,0 mm



15-113 - 15-114
HAJEK-KOFLER

Rongeurs

LOVE-GRUENWALD

15-115
2 X 10 mm

15-116
3 X 10 mm

SPURLING
15-117
4 X 10 mm



15-115 - 15-117

15-118
2 mm

15-119
3 mm

15-120
4 mm

15-121
5 mm

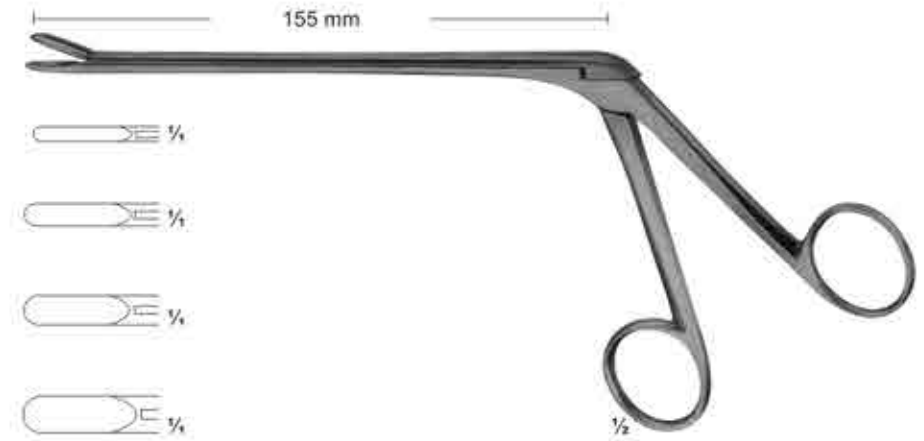

15-118 - 15-121
CASPAR

150°

15-122
2 mm

15-123
3 mm

15-124
4 mm

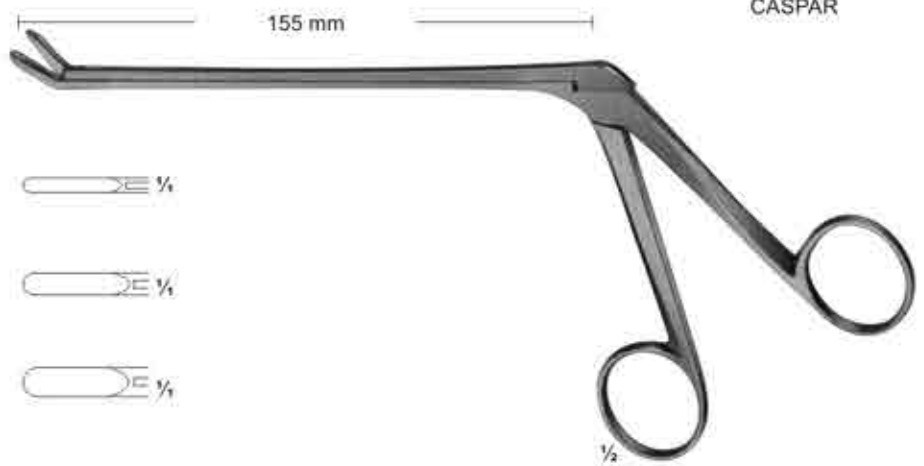

15-122 - 15-124
CASPAR

Rongeurs

Angled positions for rongeurs

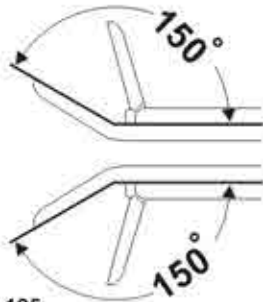

15-125
3,0 mm

15-126
3,6 mm

15-127
4,2 mm

15-128
4,8 mm

15-129
5,8 mm

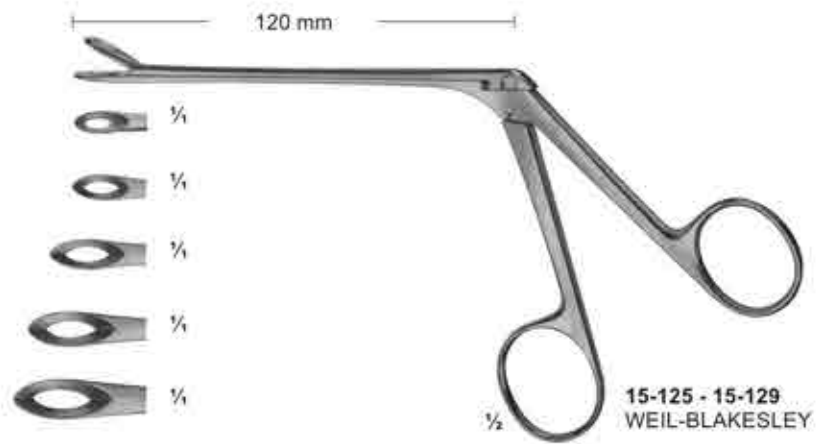
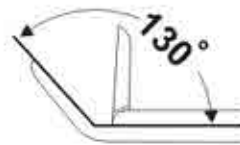
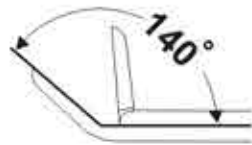

130°

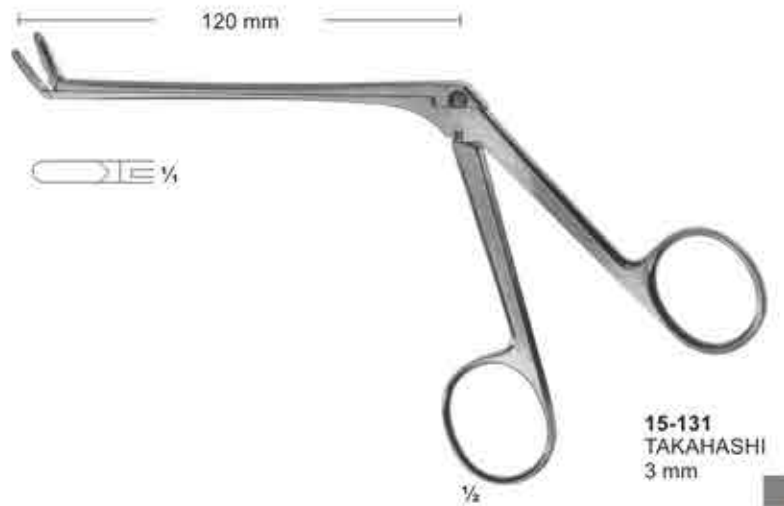

Rongeurs

150°

Lower part of jaws movable

15-132
2 mm

15-133
3 mm

15-134
4 mm



15-132 - 15-134
CASPAR

Length of shaft 140 mm	Length of shaft 160 mm	Length of shaft 185 mm	size of jaws
15-135	15-140	15-145	2 X 12 mm
15-136	15-141	15-146	3 X 12 mm
15-137	15-142	15-147	4 X 14 mm
15-138	15-143	15-148	5 X 14 mm
15-139	15-144	15-149	6 X 16 mm

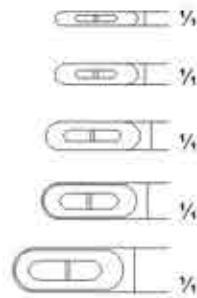

15-135 - 15-149
CASPAR

150°

Length of shaft 140 mm	Length of shaft 160 mm	Length of shaft 185 mm	size of jaws
15-150	15-153	15-156	3 X 12 mm
15-151	15-154	15-157	4 X 14 mm
15-152	15-155	15-158	5 X 14 mm

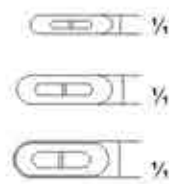

15-150 - 15-158
CASPAR

Rongeurs

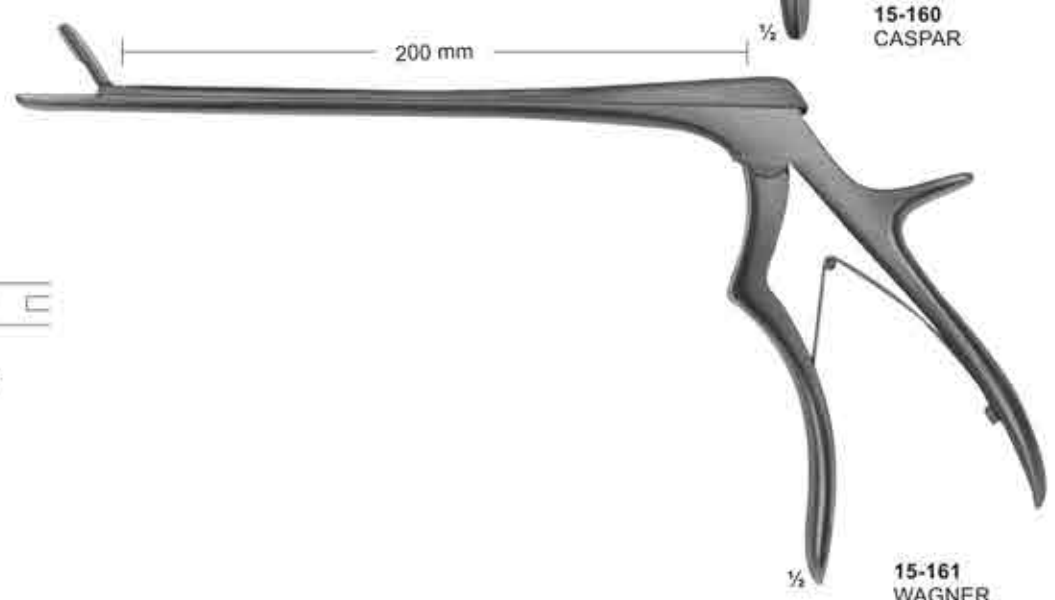
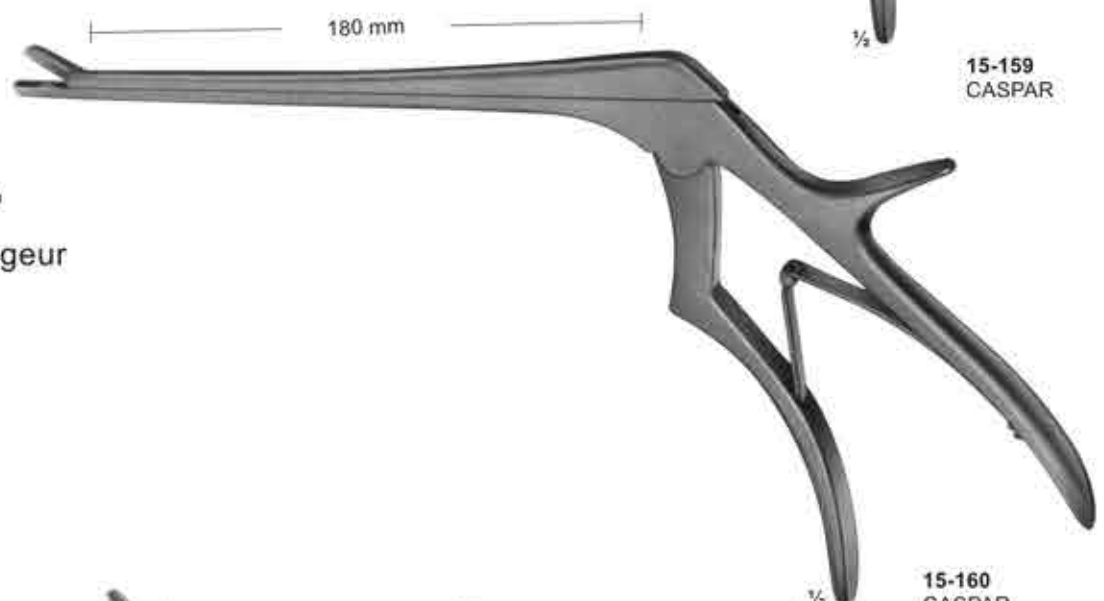
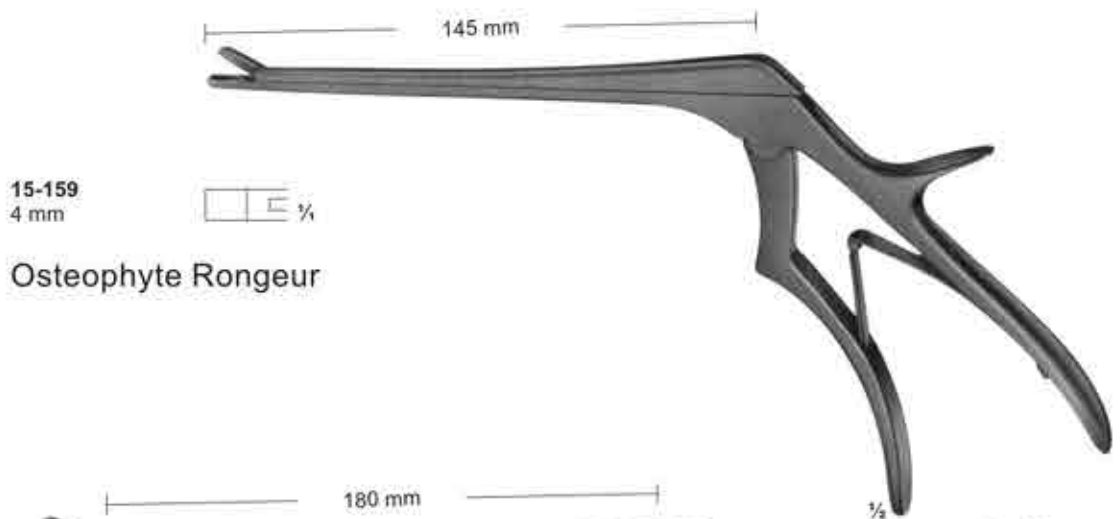

15-159
CASPAR

15-160
CASPAR

15-161
WAGNER

Elevators and Bone Levers

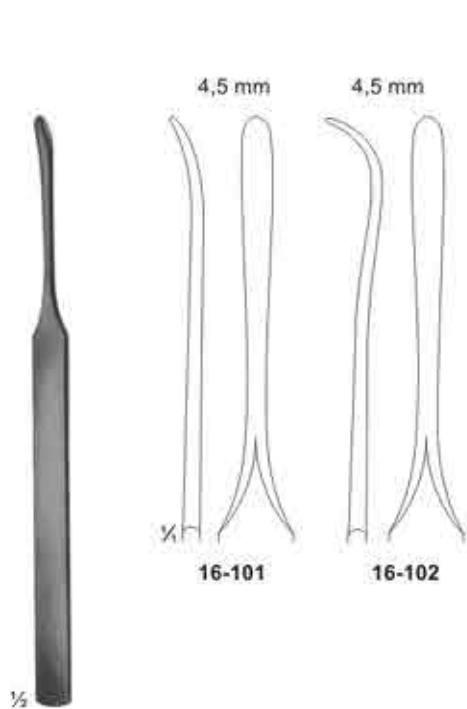

16-101 - 102
KONIG
155 mm



16-103
WILLIGER
165 mm

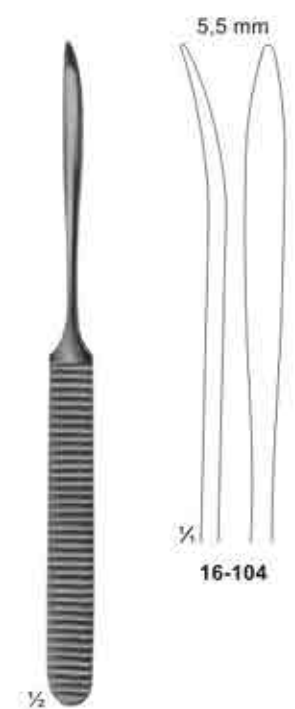

16-104
WILLIGER
170 mm

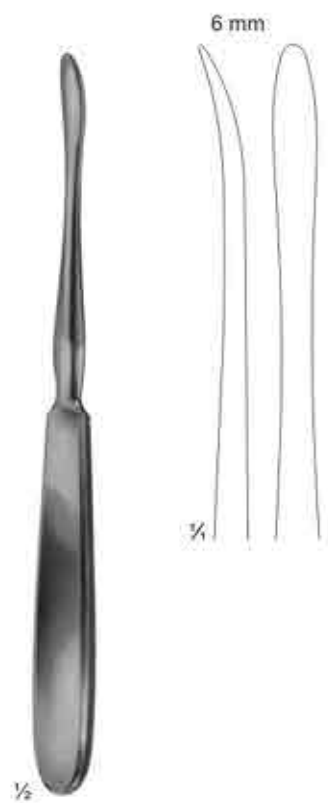

16-105
QUERVAIN
195 mm

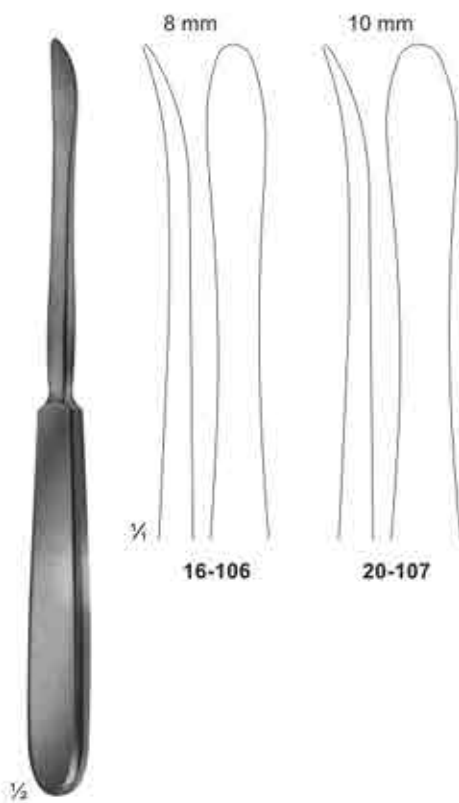

16-106 - 107
LANGENBACK
195 mm

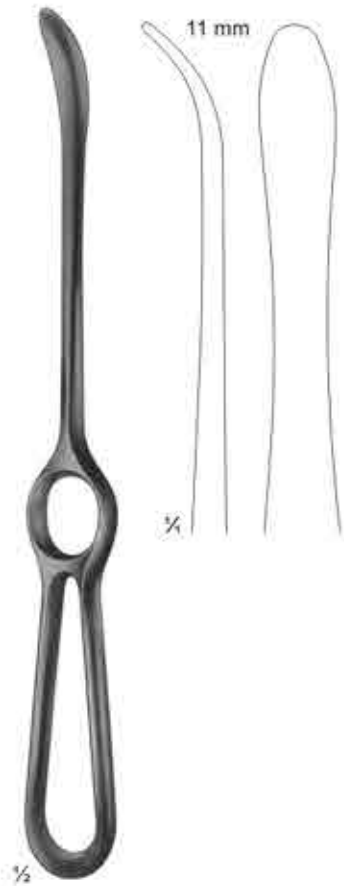

16-108
LANGENBACK
230mm

Bone Levers



16-112
30 mm
16-113
33 mm

16-109
LANE TRETHOWAN
215mm

16-110
LANE
255mm

16-111
LANGE-HOHMANN
250mm

16-112 - 113
LANGE-HOHMANN modif.
16-112 265mm
16-113 280mm

Raspatories



16-114
PARTSCH
150 mm



16-116
PARTSCH mod. LANGE
145 mm



16-117
MC KENTY
155 mm

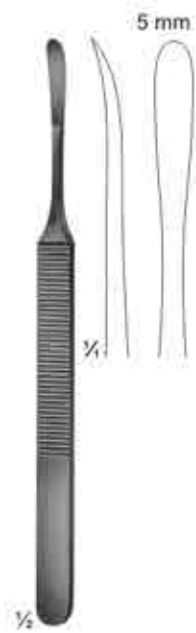

16-118
KOENIG
155 mm

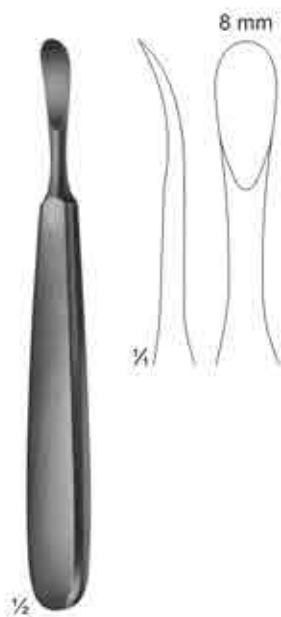

16-119
TRELAT
150 mm

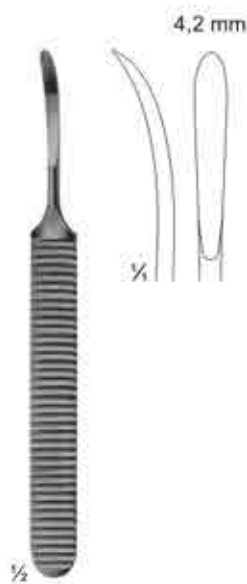

16-120
WILLIGER
140 mm



16-121
WILLIGER
160 mm

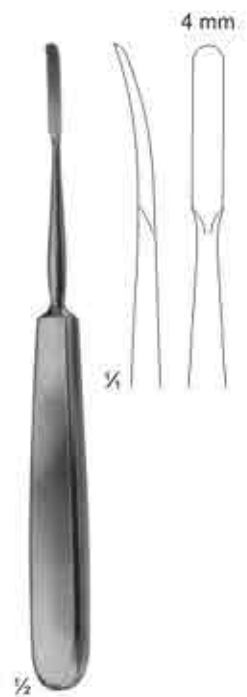

16-122
JOSEPH
170 mm

Bone File and Rasps

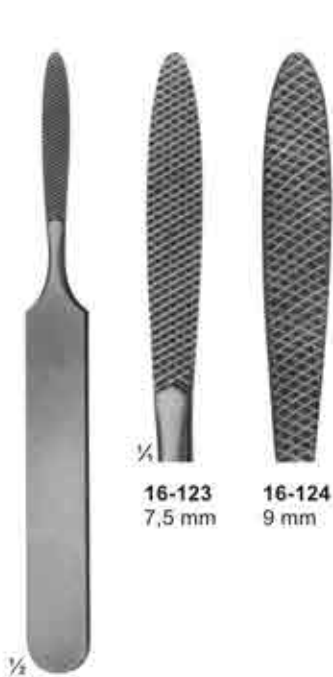

16-123
7,5 mm

16-124
9 mm

16-123
JOSEPH
fine, chequered

16-124
coarse, chequered
165 mm

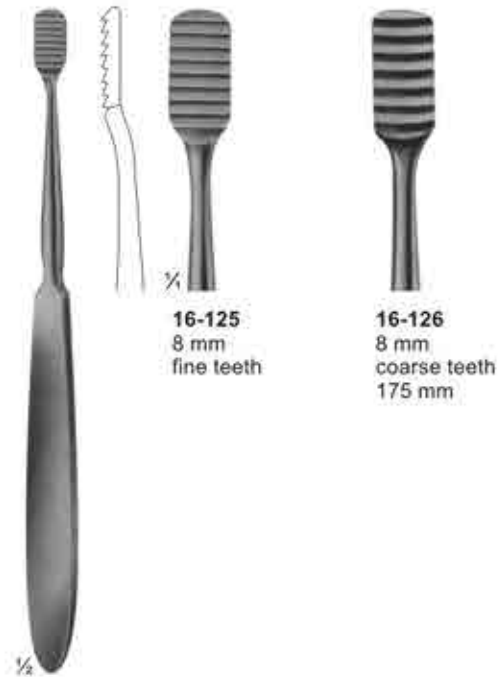

16-125
8 mm
fine teeth

16-126
8 mm
coarse teeth
175 mm

16-125 - 16-126
LEWIS



16-127
9 mm

16-127
MALTZ
down stroke
180 mm

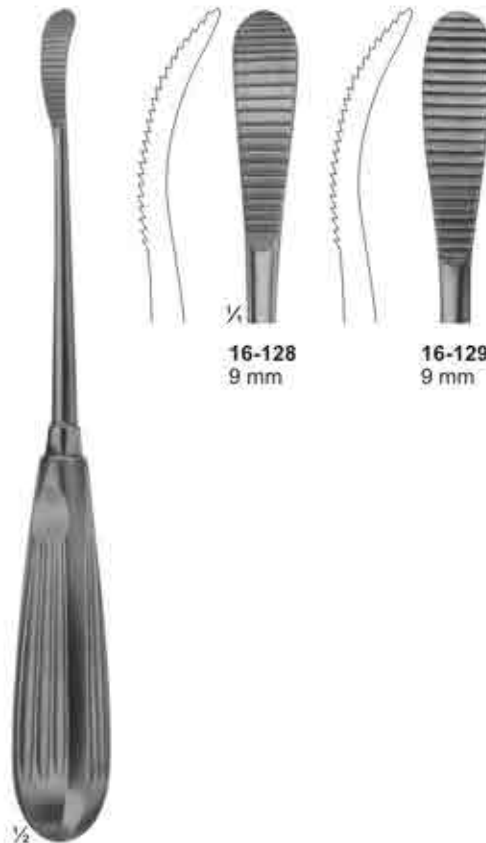

16-128
9 mm

16-129
9 mm

16-128 - 16-129
AUFRICHT
up stroke
16-129
down stroke
220 mm



16-130
6,5 mm

16-130
GALLAHER
190 mm

Bone Currettes



16-131
JACOBSON
140 mm



16-132
MARTINI
140 mm



16-133
MARTINI
140 mm



16-134
WILLIGER
145 mm



16-135
JANSEN
160 mm



16-136
BARTH
180 mm



16-137
VOLKMANN
130 mm



16-138
VOLKMANN
145 mm



16-139
VOLKMANN
170 mm

Mallets Weights refer to the heads of the mallets
Hammer Die Gewichtsangaben beziehen sich auf den Kopf des jeweiligen Hammers



∅ 20 mm

½

17-101
MEAD
 185 g
 with interchangeable
 plastic disks
 190 mm
17-102
 pair of spare disks



∅ 25 mm

½

17-103
 140 g
 with interchangeable
 plastic disks
 185 mm
17-104
 pair of spare disks



∅ 30 mm

½

17-105
COTTLE
 140 g
 1 Side Flat
 1 Side convex
 185 mm



∅ 22 mm

½

17-106
 165 g
 lead filled head
 190 mm

Osteotomes, Chisels and Gouges



17-107
MANNERFELT
Gouge
155 mm

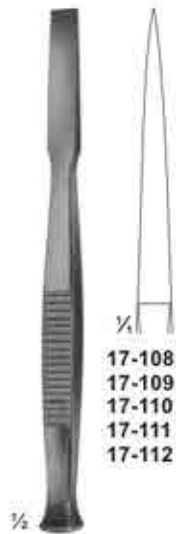

17-108 - 112
Osteotomes
140 mm

17-108 4 mm
17-109 6 mm
17-110 8 mm
17-111 10 mm
17-112 12 mm



17-113 - 117
Chisels
140 mm

17-113 4 mm
17-114 6 mm
17-115 8 mm
17-116 10 mm
17-117 12 mm



17-118 - 122
Gouges
140 mm

17-118 4 mm
17-119 6 mm
17-120 8 mm
17-121 10 mm
17-122 12 mm



PARTSCH
17-123 - 126
Chisels
140 mm

17-123 3 mm
17-124 4 mm
17-125 5 mm
17-126 6 mm

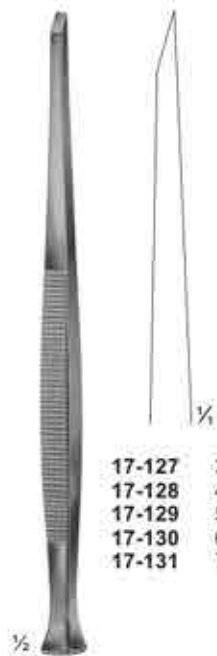

PARTSCH
17-127 - 131
Chisels
170 mm

17-127 3 mm
17-128 4 mm
17-129 5 mm
17-130 6 mm
17-131 7 mm



PARTSCH
17-132 - 135
Gouges
140 mm

17-132 3 mm
17-133 4 mm
17-134 5 mm
17-135 6 mm



PARTSCH
17-136 - 140
Gouges
170 mm

17-136 3 mm
17-137 4 mm
17-138 5 mm
17-139 6 mm
17-140 7 mm



LUCAS
17-141 - 142
Chisels
160 mm

17-141 4 mm
17-142 6 mm



LUCAS
17-143 - 144
Gouges
160 mm

17-143 3 mm
17-144 5 mm

Reposition Forceps, Bone Holding Forceps



17-145
Patella forceps
185 mm



17-146
Forceps with
ratchet fixation
140 mm



17-147
Forceps with
thread fixation
170 mm



17-148
Forceps with
thread fixation
235 mm

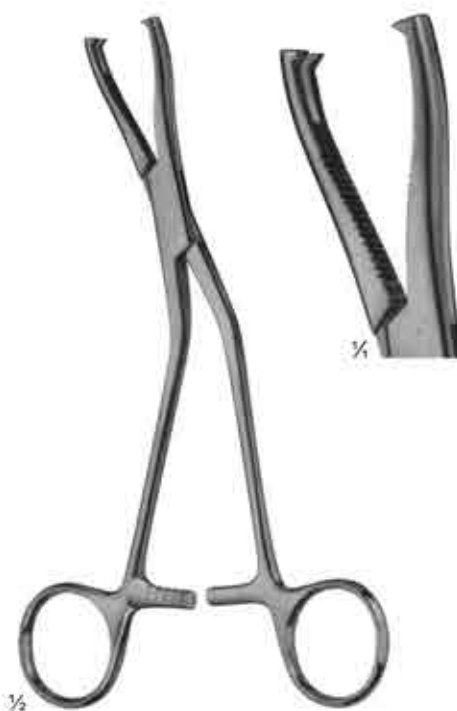

17-149
DINGMANN
185 mm

Bone Holding Forceps & Bone Clamps



Bone Rongeurs



17-158
LUER
150 mm



17-159
LUER
155 mm



17-160
BLUMENTHAL
155 mm



17-161
BLUMENTHAL
150 mm



17-162 - 163
JANSEN
175 mm

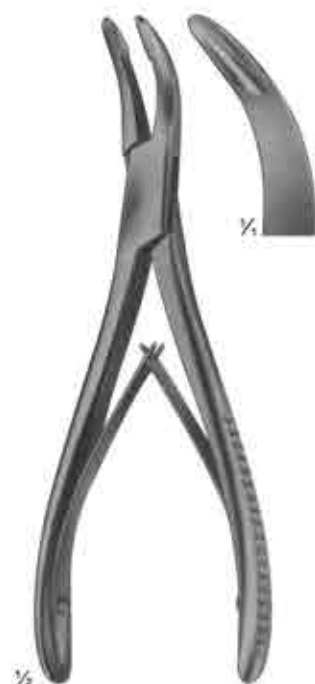

17-164
BANE-HARTMANN
175 mm

Bone Rongeurs



17-165
STILLE
235 mm.



17-166
LEKSELL-STILLE
240mm



17-167
STILLE-RUSKIN
240mm

Bone Cutting Forceps

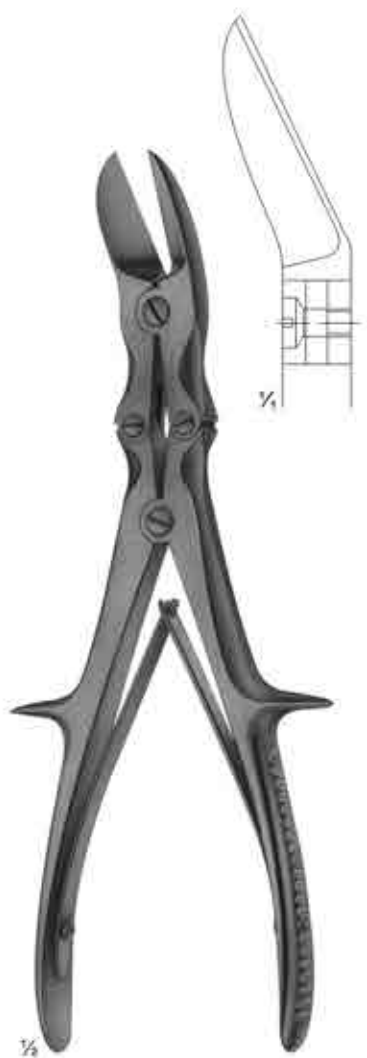

17-168
LISTON
curved on flat
240 mm



17-169
LISTON
straight
280 mm



17-170
LISTON
curved on flat
280 mm

Wire Extension

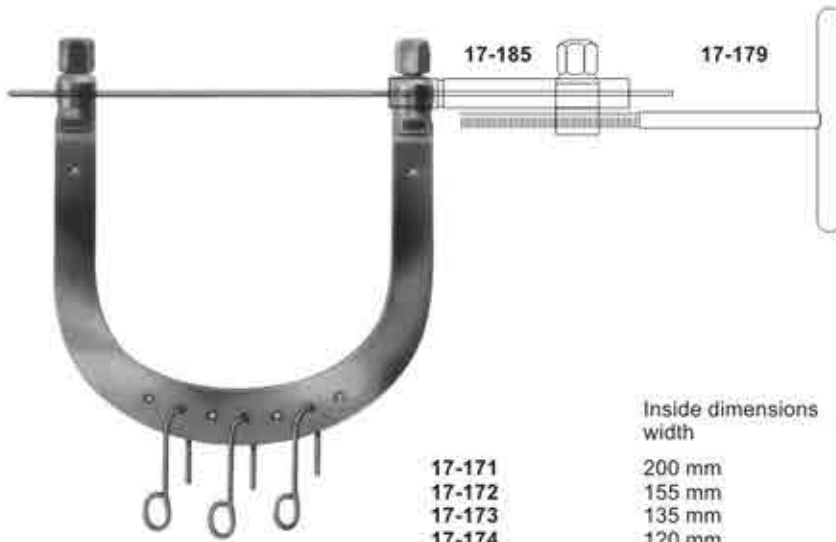

17-171 - 17-177
KIRSCHNER
 Wire traction bows,
 to be used with
KIRSCHNER-wires
 up to 2.5 mm diam.,
 With 3 hooks,
 stainless steel

	Inside dimensions width	depth	
17-171	200 mm	155 mm	for the hip
17-172	155 mm	155 mm	for the femur
17-173	135 mm	130 mm	for the knee
17-174	120 mm	120 mm	for the knee
17-175	105 mm	100 mm	for the knee
17-176	95 mm	110 mm	for the calcaneus
17-177	95 mm	70 mm	for the arm and elbow



17-178
 Wrench, double - ended,
 for wire traction bows



17-179
 Wire tightener, with
 clamping jaws



17-182	max. 105 mm
17-183	max. 160 mm
17-184	max. 200 mm
17-182	80-95 mm
17-183	90-120 mm
17-184	140-170 mm
diam upto	
17-182	1,6 mm
17-183	2,0 mm
17-184	2,5 mm

17-182 - 17-184
KIRSCHNER
 Wire traction bows, modified,
 adjustable in width, holds wire
 securely, with 1 hook



17-180
 Traction hook only,
 large size



17-181
 Traction hook only,
 small size



17-185
 Fixation clamp, to secure clamping
 jaws of 17-179 stainless steel

Cerclage Instruments

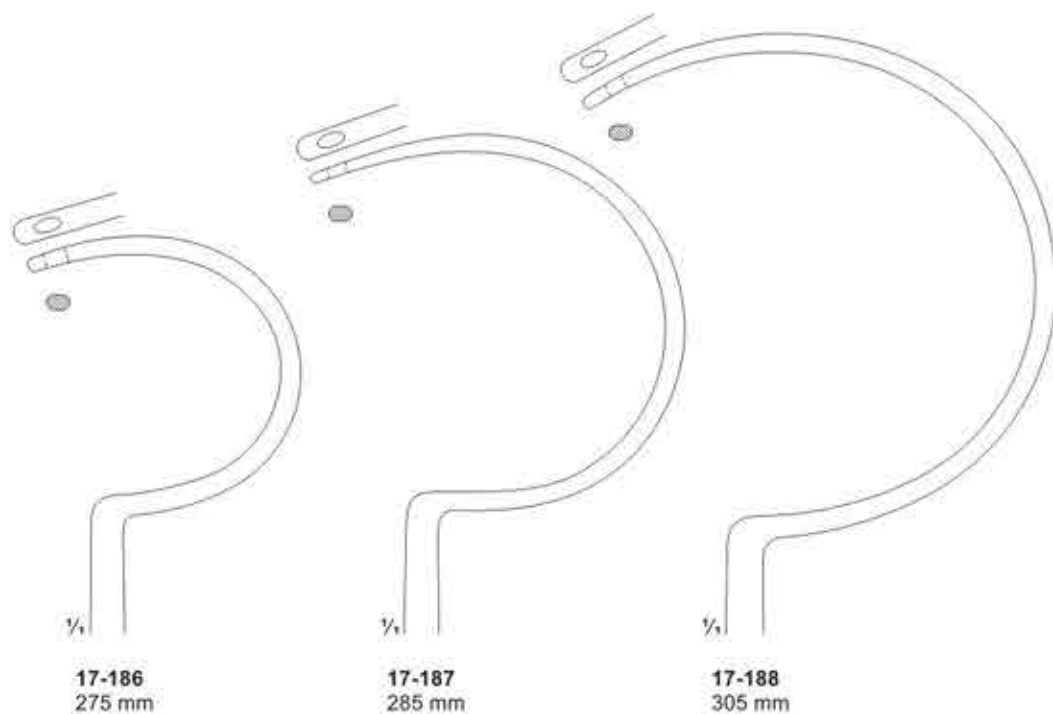

17-186 - 17-188
DEMEL
Wire guides

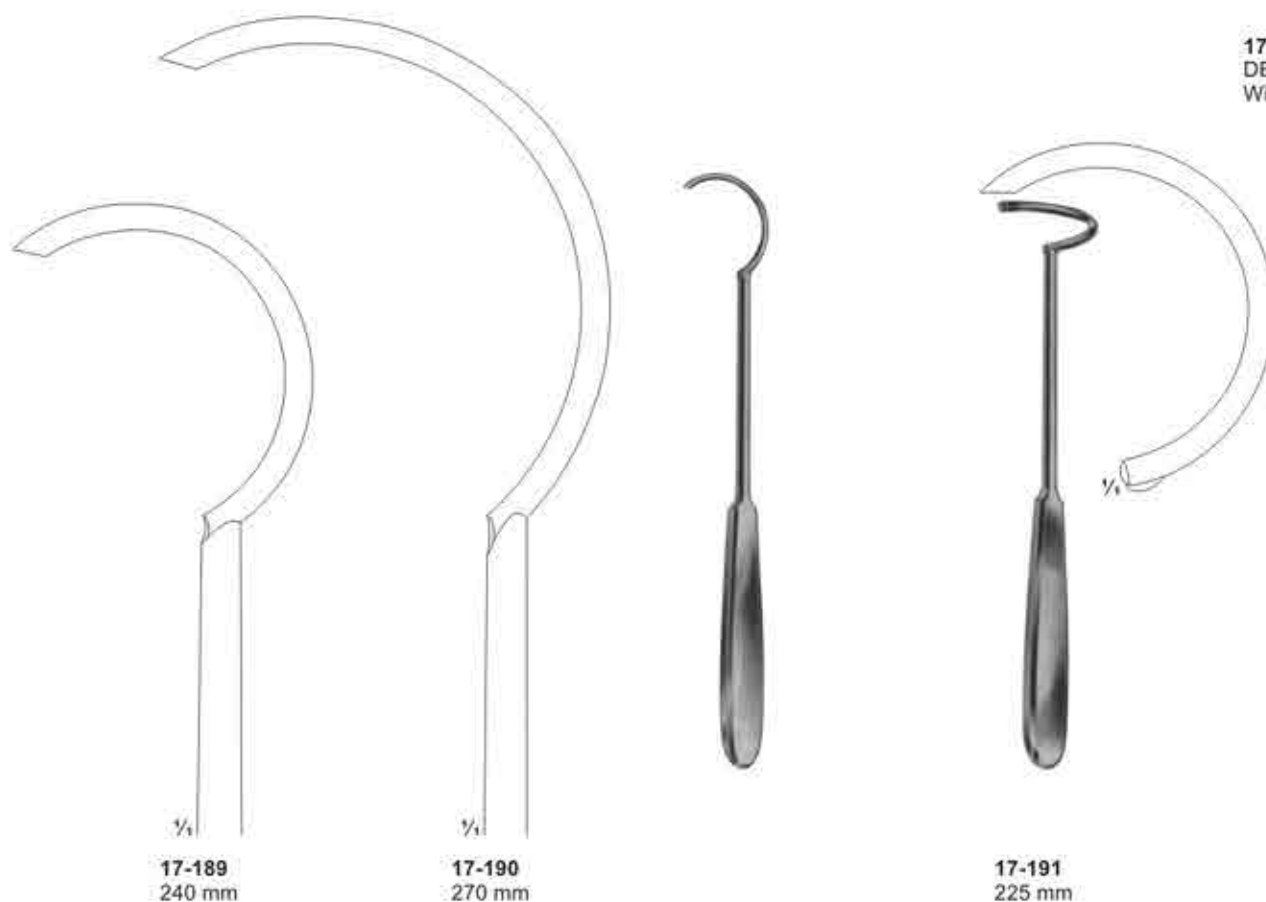

Wire Holding forceps, Wire Tightening Pliers, Flat-nosed Pliers DUROGRIP with Hard Metal Inserts



17-192
DUROGRIP
Holding forceps for cerclage wire, with lateral jaws to avoid wire slipping off
170 mm



17-193
DUROGRIP
Wire, tightening pliers, Ligature pliers
150 mm



17-194
DUROGRIP
Wire, tightening pliers, Ligature pliers
150 mm



17-195
with serrated jaws
140 mm



17-196
one jaw smooth, one jaw serrated
140 mm



17-197
with serrated jaws
17-198
with longitudinal and transversal grooves
170 mm



17-199
190 mm

Wire Holding forceps, Flat-nosed Pliers, Pliers for bending and cutting wires



17-200
130 mm

17-201
180 mm

17-200 - 17-201
Extraction pliers
for boring wires



17-202
Flat-nosed pliers,
parallel
185 mm

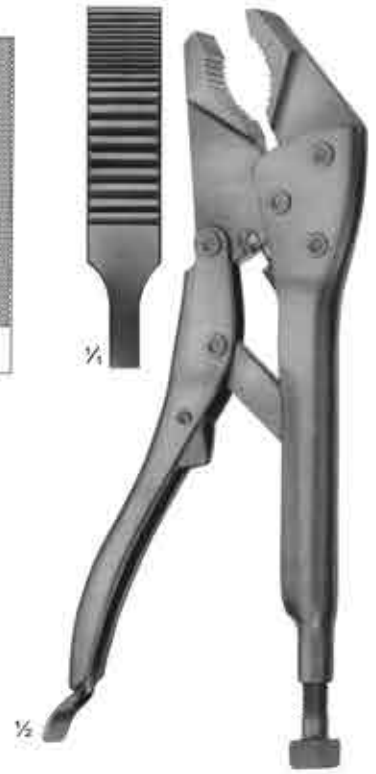

17-203
Vise grip
200 mm



17-204
Round Pliers
180mm

17-204 - 17-207

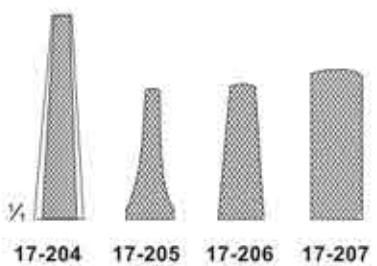

17-205 145 mm
17-206 180 mm
17-207 180 mm
Extraction pliers for wires



17-208
Bending pliers
for wires up to
1.8 mm diam.

Wire Cutters and wire Cutting Scissors DUROTIP with Carbide Cutting Edges



17-209
ANGLE
130 mm

for soft wire
up to diam.
for hard wire
up to diam.

0,5 mm
0,3 mm

17-210
DUROTIP
ANGLE
130 mm

0,6 mm
0,4 mm

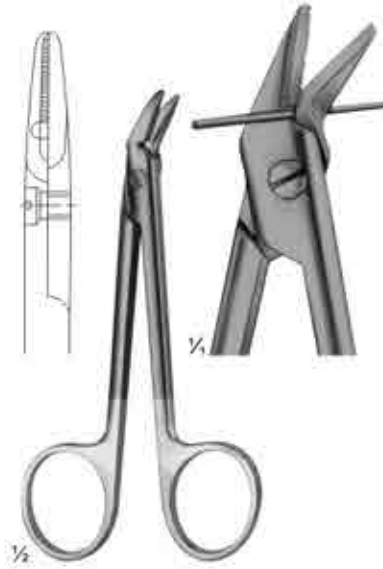

17-211
120 mm

17-212
DUROTIP
120 mm

for soft wire
up to diam.
for hard wire
up to diam.

1,2 mm
0,8 mm



17-213
HARVEY
125 mm

0,4 mm
0,3 mm



17-214
150 mm

for soft wire
up to diam
for hard wire
up to diam

1,5 mm
1,0 mm



17-215
160 mm

1,5 mm
1,2 mm



17-216
140 mm
DUROTIP
1,5 mm

1,0 mm

Wire Cutting Pliers, Lateral Cutting Action



17-217
180 mm

for soft wire
up to diam. 2,0 mm
For hard wire 1,5 mm
up to diam
specially hardened
cutting edges, front
and lateral cutting
action



17-218
REILL
175 mm

for soft wire
up to diam. 2,0 mm
For hard wire 1,6 mm
up to diam
specially hardened
cutting edges, for
cutting off wires close
to the bone



DUROTIP

17-219
235 mm

for soft wire
up to diam. 3,0 mm
For hard wire 2,2 mm
up to diam

Wire Cutting Pliers, Lateral and Front Cutting Action



17-220
240 mm

for soft wire up to diam. 2,0 mm
For hard wire up to diam. 1,6 mm



17-221
145 mm

for soft wire up to diam. 1,5 mm
For hard wire up to diam. 1,0 mm



17-222
145 mm

for soft wire up to diam. 2,0 mm
For hard wire up to diam. 1,5 mm



17-223
220 mm

for soft wire up to diam. 3,5 mm
For hard wire up to diam. 2,5 mm

Wire Cutting Pliers



17-224
320 mm

for soft wire
up to diam. 3,0 mm
For hard wire
up to diam. 3,0 mm



Cutter for cutting off
KIRSCHNER wires,
Tibia head screws,
bolts, pins, up to 3 mm diam.



DUROTIP

17-225
Cutter for cutting off
KIRSCHNER wires,
Tibia head screws,
bolts, pins, up to 6 mm diam.
470 mm

Finger Nail Instruments

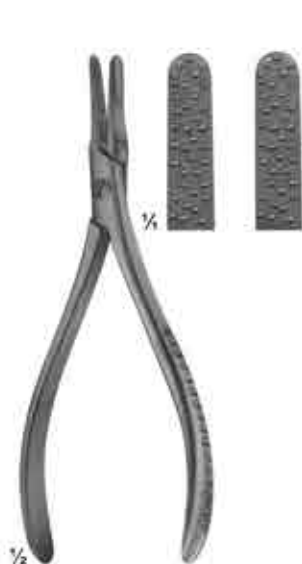

17-226
Nail extracting
forceps
135 mm



17-227
Nail extracting
forceps
145 mm

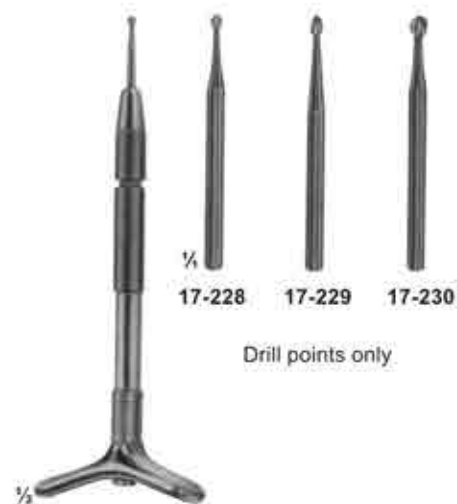

17-228
Finger nail drill
with 3 drill points

Drill points only

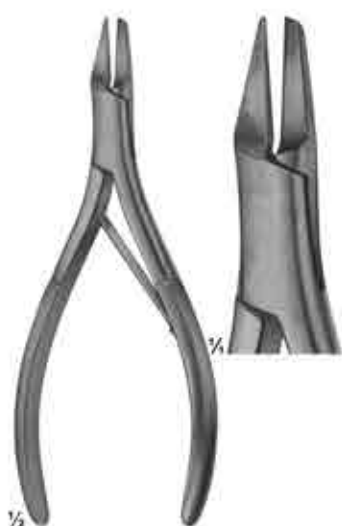

17-231
Nail splitting
forceps
135 mm



17-232
SYSTRUNK
Scissors, for splitting
finger nails
130 mm



17-233
Finger ring saw
150 mm

Spare blade
17-234

Plaster Shears



17-235
STILLE-AESCULAP
260 mm



17-236
STILLE-AESCULAP
360 mm

Plaster Spreader, Plaster Breakers



17-237
HENING
270 mm



17-238
MOD.USA
230 mm



17-239
290 mm



with removable jaws



17-240 - 17-241
WOLFF
17-240 180 mm
17-241 240 mm
plaster breakers

Vacuum Curettes for Aspiration Lipectomy, Suction Instruments

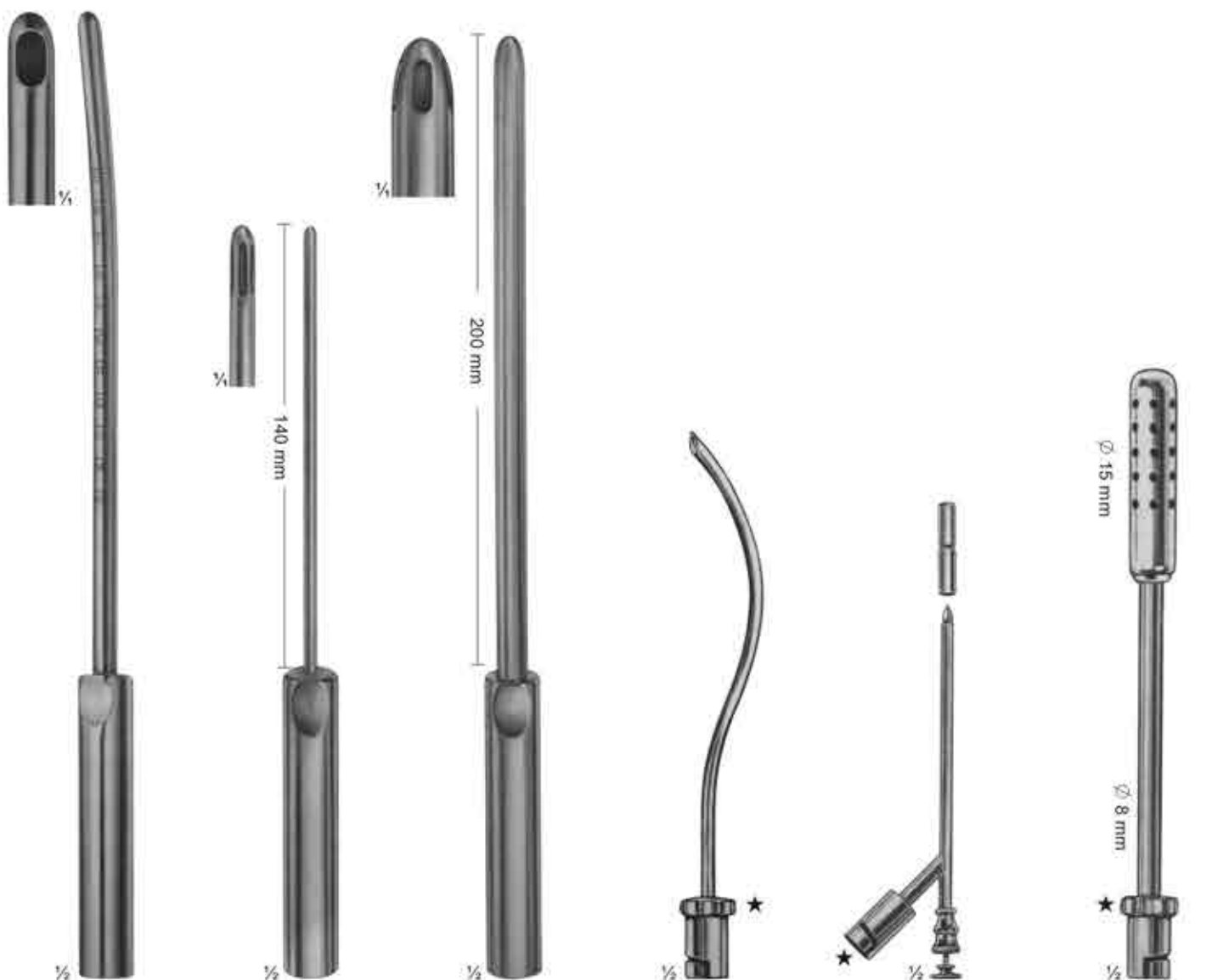

18-101 - 18-106
BIEMER
 18-101 \varnothing 4 mm
 18-102 \varnothing 6 mm
 18-103 \varnothing 8 mm
 18-104 \varnothing 10 mm
 18-105 \varnothing 12 mm
 18-106 \varnothing 14 mm
 Curettes for aspiration lipectomy, graduated, slightly curved

18-107 - 18-108
BIEMER
 18-107 \varnothing 4 mm
 18-108 \varnothing 6 mm
 Curettes for aspiration lipectomy, with three apertures, slightly curved malleable

18-109 - 18-111
BIEMER
 18-109 \varnothing 8 mm
 18-110 \varnothing 10 mm
 18-111 \varnothing 12 mm
 Curettes for aspiration lipectomy, with three apertures, slightly curved malleable

18-112
 For aspirating fluid from the excretory ducts of large glands and for keeping the operating area clear
 170 mm

18-113
 Trocar
 For puncturing
 150 mm

18-114
 For clearing large quantities of fluid
 190 mm

Suction Instruments

18-115 150mm
Suction handle, with vacuum regulator and finger cut-off, brass, mirror-finish chromium-plated



olive
Ø9 mm

18-116 170mm
Suction handle, with hand regulation valve and quick-shutter, brass, mirror-finish chromium-plated



Both suction handles have bayonet fitting olive and can be used for the suction cannulae. Ø9 mm



18-117
Trocar
For puncturing
170 mm



18-118
Hollow needle,
sharp
150 mm



18-119
double curved
For general
surgery
230 mm



18-120
For tonsillectomy,
oral and laryngeal
operations
190 mm



18-121
For tonsillectomy,
oral and laryngeal
operations
220 mm

★ With bayonet fitting to be used with suction handles (18-115 - 18-116)

Suction Instruments

18-122
WULLSTEIN
 Suction tube, conical, silver, olive
 with LUER hub
 160 mm



18-123 1.5 mm
18-124 2.0 mm
WULLSTEIN
 Suction tube, cylindrical, silver, with
 stylet olive with LUER hub
 160 mm



Usable length

YASARGIL usable length diam:		YASARGIL usable length diam:	
18-125	130 mm 1,5 mm	18-133	130 mm 2,5 mm
18-126	150 mm 1,5 mm	18-134	150 mm 2,5 mm
18-127	180 mm 1,5 mm	18-135	180 mm 2,5 mm
18-128	220 mm 1,5 mm	18-136	220 mm 2,5 mm
18-129	130 mm 2,0 mm	18-137	130 mm 3,5 mm
18-130	150 mm 2,0 mm	18-138	150 mm 3,5 mm
18-131	180 mm 2,0 mm	18-139	180 mm 3,5 mm
18-132	220 mm 2,0 mm	18-140	220 mm 3,5 mm
		18-141	180 mm 4,5 mm

olive
 \varnothing 6,5-9 mm
 with LUER hub

18-142 - 18-144
LANDOLT
 150 MM
 diam \varnothing 3 mm

18-142 8 mm / curved
18-143 11mm / curved
18-144 15mm / curved

\varnothing 3.5 mm

\varnothing 2.0 mm

18-145 500 mm
18-146 350 mm
 with rubber tip,
 with LUER hub

olive \varnothing 9 mm

18-147 2.0 mm diam
18-148 2.5 mm diam
18-149 3.0 mm diam
 with finger cut-off,
 thumb piece 90° to
 curve, with LUER hub
 250 mm

olive \varnothing 6-9 mm

Combined Suction and Irrigation Cannulae, Coagulation Suction Cannulae



18-151
YASARGIL
LUER-LOCK cone
200 mm

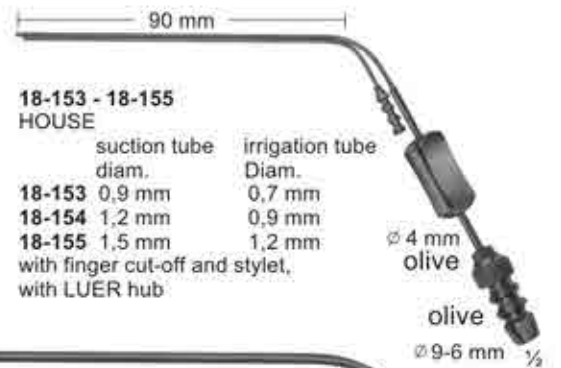

4 mm diam., Untarnished contact to be touched by HF-electrodes

Suction Instruments

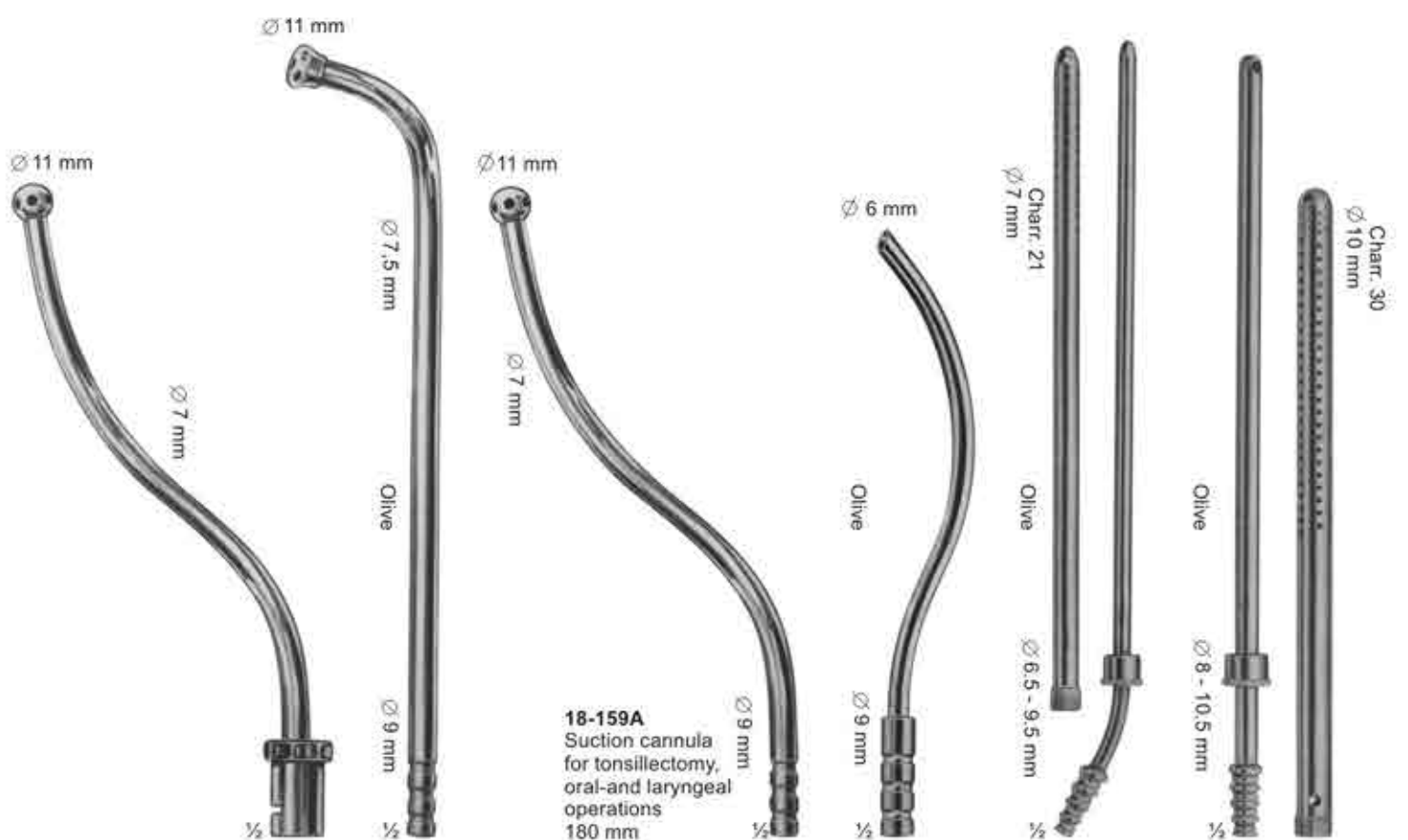

18-158
For tonsillectomy,
oral-and laryngeal
operations
180 mm

18-159
Suction cannula
for tonsillectomy,
oral-and laryngeal
operations
220 mm

18-159A
Suction cannula
for tonsillectomy,
oral-and laryngeal
operations
180 mm

18-160
S-shaped blunt cannula
for aspirating fluid from
the excretory ducts of
large glands and for
keeping the operating
area clear
170 mm

18-161
POOL
Suction cannula,
with outer tube
to be screwed off
225 mm

18-162
POOL
Suction cannula,
with outer tube
to be screwed off
225 mm

Suction Instruments



- 18-163 Ø 1,5 mm
- 18-164 Ø 2,0 mm
- 18-165 Ø 2,5 mm
- 18-166 Ø 3,0 mm

18-163 - 18-166
PLESTER
 with finger cut-off and
 stylet, thumb piece
 parallel to curve, with
 LUER hub
 195 mm



- 18-167 Ø 2,0 mm
- 18-168 Ø 2,5 mm
- 18-169 Ø 3,0 mm
- 18-170 Ø 4,0 mm
- 18-171 Ø 5,0 mm

18-167 - 18-171
FERGUSSON
 with finger cut-off and
 stylet, thumb piece
 90° to curve, with
 LUER hub
 180 mm



18-172 Ø 4,0 mm
FERGUSSON
 with finger cut-off
 and stylet, thumb piece 90°
 to curve, with LUER hub
 180 mm



18-173 Ø 3,0 mm
18-174 Ø 5,0 mm
FRAZIER
 insulated, with finger
 cut-off and stylet, thumb
 piece 90° to curve,
 with LUER hub
 180 mm



18-175
 5,0 mm diam., Tip
 6,5 mm wide, Nasal
 suction tube, with
 LUER hub
 180 mm



18-176 Ø 4,5 mm
18-177 Ø 5,5 mm
 Nasal suction
 tubes
 175 mm



18-178
GORNEY
 Suction dissector
 180 mm



18-179 4 mm wide
18-180 5 mm wide
 Suction raspatories,
 sharp, bayonet-shaped,
 with stylet
 200 mm



18-181
LOPEZ-REINKE
 Tonsil dissector with
 suction device
 235 mm

Dissection Instruments



18-182

- 1- Blow pipe .
- 2- 3 PCS .scalpel.
- 3- Dissecting forcep 13 cm.
- 4- Grooved director with tounge tie 13 cm.
- 5- Triple chain hook.
- 6- Dressing scissors probe pointed 13 cm.
- 7- Probe double 13 cm.
- 8- Zipper case inside red velvet.



18-183

- 1- Probe Double 13 cm
- 2- 2 PCS. Scalpel S.S
- 3- Grooved Director With tongue Tie 13 cm
- 4- Mayo Hegar Needle Holder 13cm
- 5- Dissecting Forcep 13 cm 1x2 Teeth
- 6- Dressing Forcep 13 CMS Serrated.
- 7- Dressing Scissor 13 cm S/B STR.
- 8- Dressing Scissor 13 cm S/B CVD.
- 9- Zipper Case Inside Red Velvet.

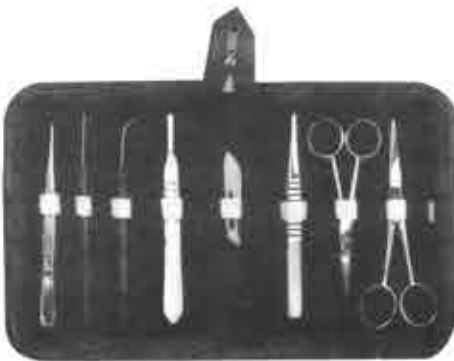

18-184

- 1- Dissecting Forcep 11.5 cm Sharp Point.
- 2- Iris Scissor
- 3- B.P Handle No. 4
- 4- Teasing Needle Sharp angular.
- 5- Blade No. 22
- 6- Thumb Forceps T.O.E 13 cm
- 7- Dissecting Scissor STR 11.5 cm
- 8- Dissecting Scissor STR 13 cm
- 9- Zipper case Inside Red Velvet



18-185

- 1- Grooved Director with Tongue Tie 14 cm
- 2- Probe Double 14cm
- 3- Mayo Hegar Needle Holder 14 cm
- 4- BP. Handle no.3
- 5- BP. Handle no.4
- 6- Dressing Scissor 14 cm S/B STR
- 7- Dressing Scissor 14 cm S/B CVD.
- 8- Dressing Forcep 1x2 Teeth 14 cm
- 9- Dressing Forcep Serrated 14 cm



18-186

- 1- Probe double 12.5 cm
- 2- Scalpel
- 3- B.P Handle No. 4
- 4- 6 PCS Blade 2 each no. 21, 22, 23
- 5- Dissecting Forcep 12.5 cm
- 6- Dissecting Forcep 11.5 cm sharp Point.
- 7- Dissecting Scissor S/B STR 13 cm
- 8- Dissecting Scissor S/S STR 13 cm



18-187

- 1- Teasing Needle with Chuck CVD.
- 2- Huber Probe
- 3- Iris Scissor
- 4- Dissecting Forcep Fine 14 cm.
- 5- Dissecting Forcep Fine CVD. 12 cm
- 6- Operating Scissor with Probe 14 cm.
- 7- B.P. Handle no. 4

Dissection Instruments



18-188

- 1- Probe with eye
- 2- Dissecting Forcep cvd fine 12 cm.
- 3- Iris Scissor
- 4- Operating Scissor S/B str 14 cm
- 5- Grooved Director and Tongue tie
- 6- Huber Probe
- 7- Triple Chain Hook
- 8- B.P Handle No. 4
- 9- B.P Handle No. 3
- 10- Teasing Needle with Chuck cvd.
- 11- Teasing Needle with Chuck str.
- 12- Dissecting Forceps Fine 14 cm.



18-190

- 1- Iris Scissor STR
- 2- Dissecting Forceps CVD 12 cm.
- 3- Scalpel
- 4- Teasing Needle STR wooden handle.
- 5- Teasing Needle CVD wooden handle.
- 6- Watchmaker fine point.



18-192

- 1- Probe double end.
- 2- Grooved director and tongue tie.
- 3- B.P handle no.4
- 4- Operating scissor STR S/b14cm.
- 5- Kelly forceps STR 14cm.
- 6- Dissecting forceps thumb 13cm.



18-189

- 1- Grooved Director and Tongue tie
- 2- Mayo Hearn Needle Holder 14 cm
- 3- B.P Handle No. 4
- 4- Dissecting Forceps Thumb 14 cm.
- 5- Operating Scissor S/B str 14 cm
- 6- Kelly Forcep STR 14 cm.
- 7- Probe Double end



18-191

- 1- Probe Double end
- 2- B.P Handle No. 4
- 3- Dissecting Forcep 1x2 Teeth 14 cm.
- 4- Operating Scissor S/B str 14 cm
- 5- Mayo Hearn Needle Holder 14 cm
- 6- Kelly Forcep STR 14 cm.
- 7- Operating Scissor S/B CVD 14 cm
- 8- Grooved Director and Tongue tie
- 9- Dissecting Forceps Thumb 14 cm.



18-193

- 1- Dissecting Forceps Thumb 14 cm
- 2- Dissecting Forcep 1x2 Teeth 14 cm.
- 3- B.P Handle No. 3
- 4- Grooved Director and Tongue tie
- 5- Mayo Hearn Needle Holder 14 cm
- 6- Operating Scissor S/B str 14 cm
- 7- Probe Double end
- 8- Kelly Forcep STR 14 cm.

Dissection Instruments



18-194

- 1- Dissecting Forcep Fine 14cm.
- 2- Dissecting Forcep Fine CVD 12cm
- 3- Dissecting Forcep with Pin 14cm.
- 4- Watchmaker Fine point
- 5- Iris scissor STR
- 6- Iris scissor CVD.
- 7- Teasing Needle holder
- 8- Teasing Needle STR.
- 9- B.P. Handle no. 3



18-195

- 1- Teasing Needle STR.
- 2- Grooved Director and Tongue Tie.
- 3- Teasing Needle CVD.
- 4- Dissecting Forcep with Pin 12 cm Fine
- 5- Operating Scissor S/B STR 14 cm
- 6- Triple Chain Hook
- 7- Probe with eye
- 8- Probe Double end
- 9- Probe and Hook
- 10- Dissecting Forcep Fine 14 cm
- 11- Iris Scissor
- 12- Huber Probe
- 13- B.P. Handle no.3
- 14- B.P. Handle no.4



18-196

- 1- Dissecting forcep fine STR with pin 12cm.
- 2- Iris scissor STR.
- 3- Probe with eye.
- 4- Probe and hook.
- 5- Operating scissor S/B STR 14cm
- 6- Triple chain hook.
- 7- B.P. handle no.4
- 8- Humber probe.
- 9- B.P.handle no.3
- 10- Teasing needle STR plastic handle.
- 11- Teasing needle CVD plastic handle.
- 12- Grooved director and tongue tie.
- 13- Probe double end.



18-197

- 1- Dissecting Forceps Thumb 14 cm.
- 2- Dissecting Forcep 1x2 Teeth 14 cm.
- 3- B.P Handle No. 3
- 4- Grooved Director and Tongue tie
- 5- Mayo Hearn Needle Holder 14 cm
- 6- Operating Scissor S/B str 14 cm
- 7- Probe Double end
- 7- Kelly Forcep STR 14 cm.

Hospital Wares



19-101 - 115
Schimmelbusch

	Ø x H sizes in mm
19-101	80 x 80
19-102	105 x 120
19-103	140 x 140
19-104	160 x 120
19-105	160 x 150
19-106	190 x 150
19-107	190 x 190
19-108	240 x 160
19-109	240 x 240
19-110	290 x 160
19-111	290 x 240
19-112	340 x 160
19-113	340 x 340
19-114	390 x 190
19-115	390 x 290



19-116
Box
120 x 65 x 13mm
(without Bulldog clamps,
without silicone tape)



19-117
Box with support
120 x 65 x 13 mm
(ohne Bulldogklemmen)



19-118
Box with support for
needle electrodes,
without instruments



19-119 - 121
50 x 25 x 4,5 mm
19-120
65 x 42 x 8 mm
19-121
75 x 25 x 4,5 mm



19-122
Ø 65mm x 15mm

Hospital Wares



19-123 - 131

	∅ x H
19-123	30 x 90 mm
19-124	50 x 100 mm
19-125	50 x 130 mm
19-126	50 x 175 mm
19-127	75 x 100 mm
19-128	75 x 130 mm
19-129	75 x 175 mm
19-130	100 x 175 mm
19-131	100 x 200 mm



19-141 - 142

- 19-141** Martin Sterilizing Forceps consisting of:
 1 Sterilizing Forceps, curved, 25 cm, without ratchet, with lid for jar
 1 jar with bottom plate (anti-tilt)
- 19-142** ditto, with 32 cm long Sterilizing Forceps



19-132 - 139

19-132	165 x 85 x 35 mm
19-133	200 x 100 x 35 mm
19-134	200 x 100 x 50 mm
19-135	230 x 130 x 50 mm
19-136	260 x 150 x 50 mm
19-137	270 x 235 x 50 mm
19-138	300 x 200 x 50 mm
19-139	325 x 275 x 50 mm



19-140
 205 x 105 x 35 mm

Round Metal Boxes and Medicine Cups



19-143 - 148

∅ x H

19-143	75 x 60 mm
19-144	75 x 75 mm
19-145	100 x 60 mm
19-146	100 x 100 mm
19-146A	125 x 80 mm
19-147	125 x 125 mm
19-148	150 x 150 mm



19-149
25 cc

19-150
50 cc



19-151
20 cc
Medicine Spoon



19-152
∅ 75 x 12 mm
Tablet Tray



19-153
∅ 90 x 90 mm
Metal Cup



19-154
∅ 75 x 80 mm
Sputum Cup



Kidney Dish



19-155 - 157

19-155	170 x 100 x 35 mm
19-156	250 x 140 x 40 mm
19-157	275 x 150 x 45 mm

Hospital Wares



19-158 - 165

	Ø x H		
19-158	40 x 19 mm	0.05L	
19-159	61 x 30 mm	0.07L	
19-160	80 x 40 mm	0.14L	
19-161	116 x 50 mm	0.35L	
19-162	128 x 55 mm	0.45L	
19-163	147 x 65 mm	0.70L	
19-164	167 x 75 mm	1.10L	
19-165	187 x 85 mm	1.60L	



19-166 - 170

19-166	116 x 35 mm	0.30L
19-167	128 x 38 mm	0.40L
19-168	147 x 40 mm	0.50L
19-169	157 x 45 mm	0.75L
19-170	187 x 45 mm	1.00L



19-171
Ø 110 x 28 mm 0.15L



19-172
100 cc 0.1L



19-173 - 176
19-173 0,25L
19-174 0,50L
19-175 1,00L
19-176 2,00L



19-177
235 x 190 x 40 mm



19-178
Ø 220 x 70 mm

Hospital Wares



19-179
∅ 50 x 100 mm
Powder Pot



19-180
∅ 50 x 75 mm
Methot With Lid



19-181
∅ 50 x 75 mm
Methot Without Lid



19-182



19-183



19-184



19-185 - 186

19-185 ∅ 235 mm
19-186 ∅ 310 mm

Needle Cases



19-187
Sauerbruch
210 x 125 x 17 mm



19-188
Sauerbruch
210 x 125 x 17 mm



19-189
150 x 95 x 13 mm



19-190
150 x 95 x 13 mm



19-191
150 x 95 x 13 mm



19-192
150 x 95 x 13 mm



19-193
150 x 95 x 13 mm



19-194
150 x 95 x 13 mm



19-195
150 x 95 x 11 mm

Storing Cases



19-199 - 209

19-199	230 x 130 x 50	mm
19-200	260 x 150 x 50	mm
19-201	275 x 235 x 50	mm
19-202	300 x 200 x 50	mm
19-203	325 x 275 x 50	mm
19-204	420 x 175 x 50	mm
19-205	230 x 130 x 75	mm
19-206	260 x 150 x 75	mm
19-207	300 x 200 x 75	mm
19-208	325 x 275 x 75	mm
19-209	420 x 175 x 75	mm



19-196
Deponette
245 x 135 x 35mm



19-197
Deponette
245 x 135 x 50mm



19-198
Deponette
245 x 135 x 60mm

Sterilizing Baskets / Trays



19-210 - 212

19-210	480 x 250 x 50	mm
19-211	520 x 250 x 75	mm
19-212	520 x 250 x 100	mm

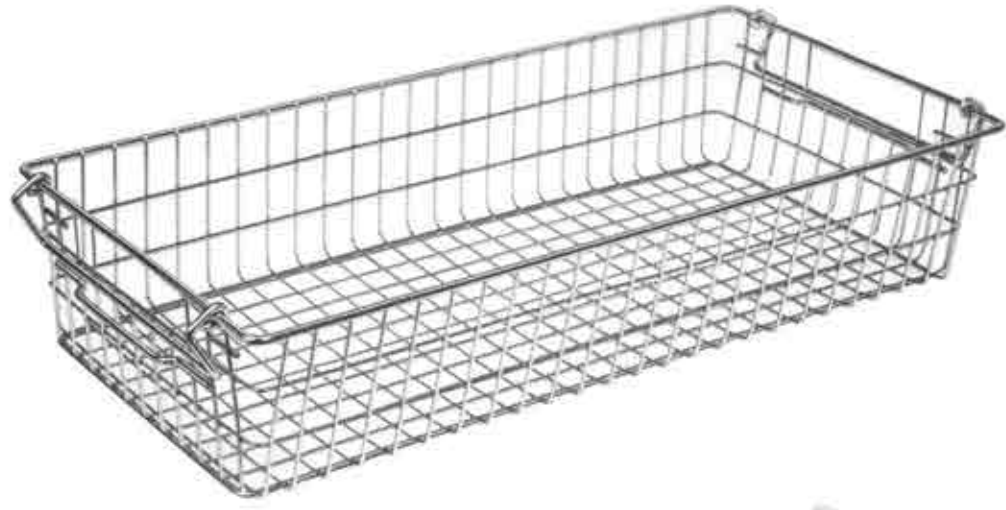

19-219
(60 x 30 x 15 cm)
Nominal dimensions



19-213 - 218

19-213	240 x 240 x 50	mm
19-214	240 x 240 x 80	mm
19-215	240 x 240 x 100	mm
19-216	480 x 260 x 50	mm
19-217	520 x 260 x 80	mm
19-218	520 x 260 x 100	mm

Scissors with Tungsten Carbide Inserts

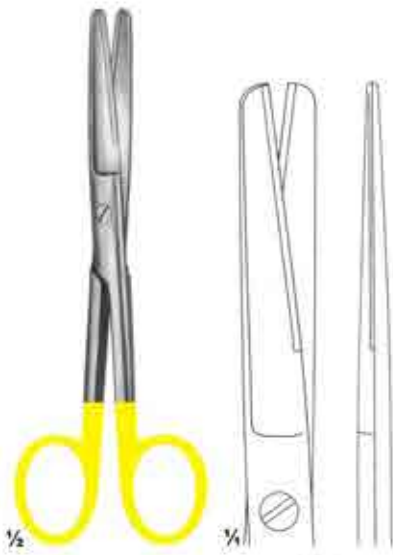

26-101
Standard

14,5cm
16,5cm
18,5cm

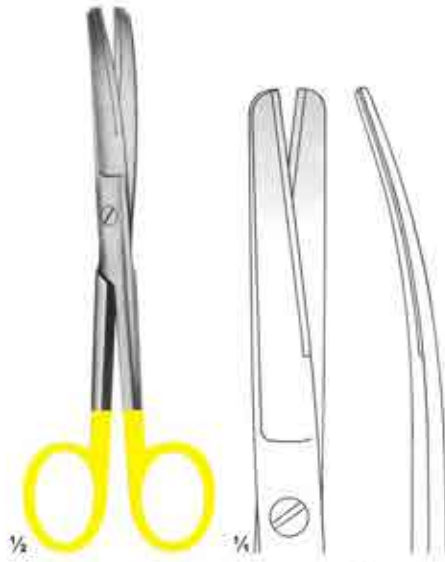

26-102
Standard

14,5cm
16,5cm
18,5cm



26-103
Standard

14,5cm
16,5cm
18,5cm



26-104
Standard

14,5cm
16,5cm
18,5cm



26-105
Standard

14,5cm
16,5cm
18,5cm



26-106
Standard

14,5cm
16,5cm
18,5cm

Scissors with Tungsten Carbide Inserts



1/2
26-107
 Mayo-Lexer

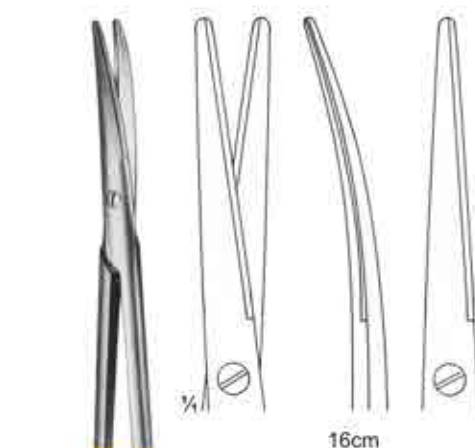

1/2
26-108
 Mayo-Lexer

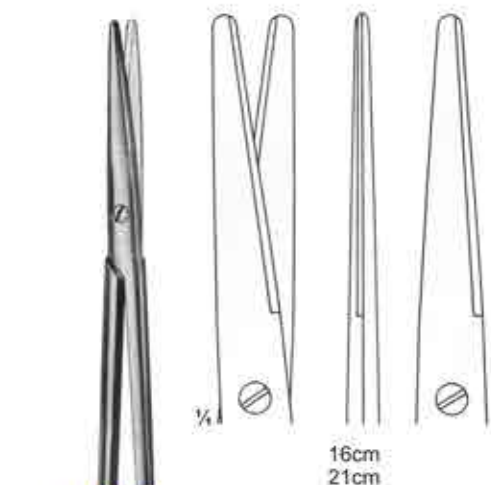

1/2
26-109
 Lexer

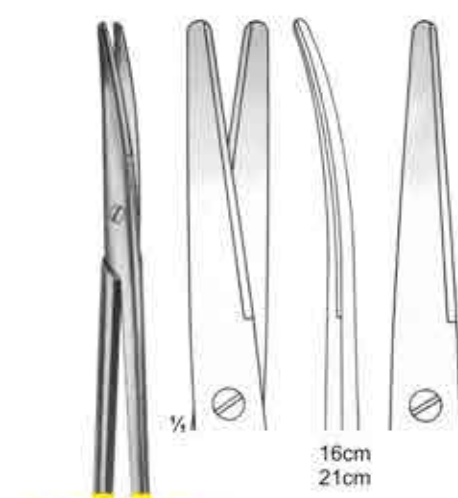

1/2
26-110
 Lexer

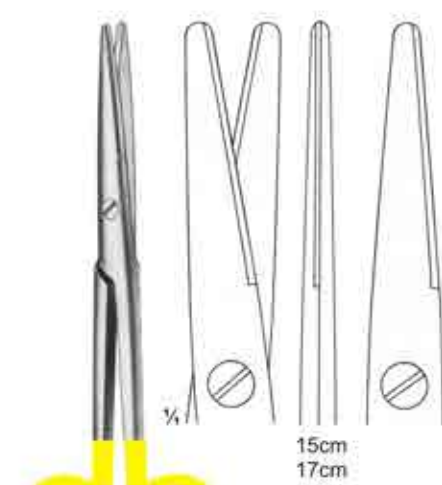

1/2
26-111
 Mayo-Stille

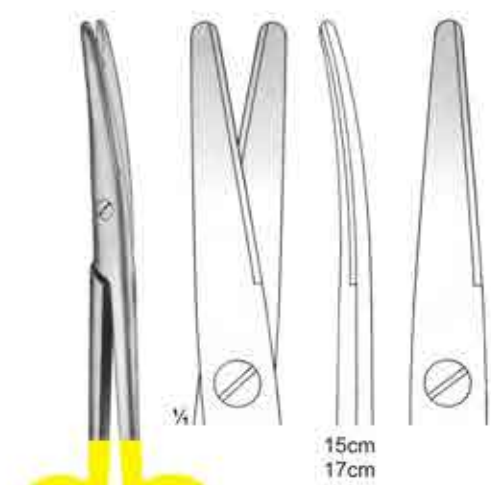

1/2
26-112
 Mayo-Stille

Scissors with Tungsten Carbide Inserts



26-113
Metzenbaum

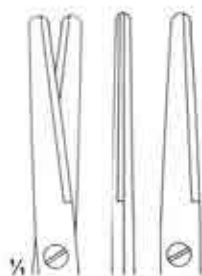

18cm 11,5cm
20cm 14,5cm
28cm 23,5cm
30cm 25,5cm



26-114
Metzenbaum

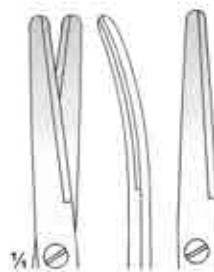

11,5cm 14,5cm
23cm 25cm



26-115
Metzenbaum



18cm 20cm
28cm 30cm



26-116
Metzenbaum-Fino

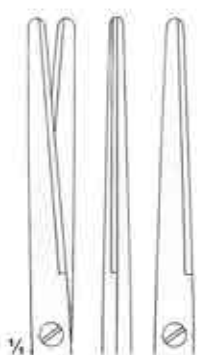

14cm 18cm 20cm
23cm 25cm 28cm



26-117
Metzenbaum-Fino

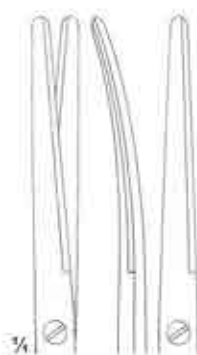

14cm 18cm 20cm
23cm 25cm 28cm



26-118
Metzenbaum-Fino



14cm 18cm
20cm 23cm

Scissors with Tungsten Carbide Inserts



1/4
26-119
 Metzenbaum-Fino

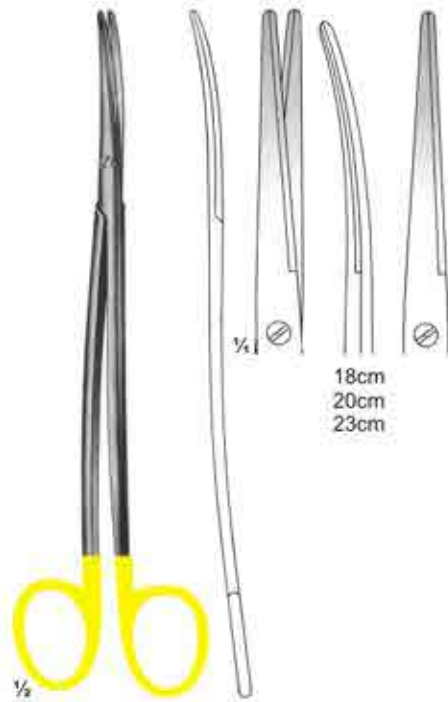

1/4
26-120
 Metzenbaum-Fino

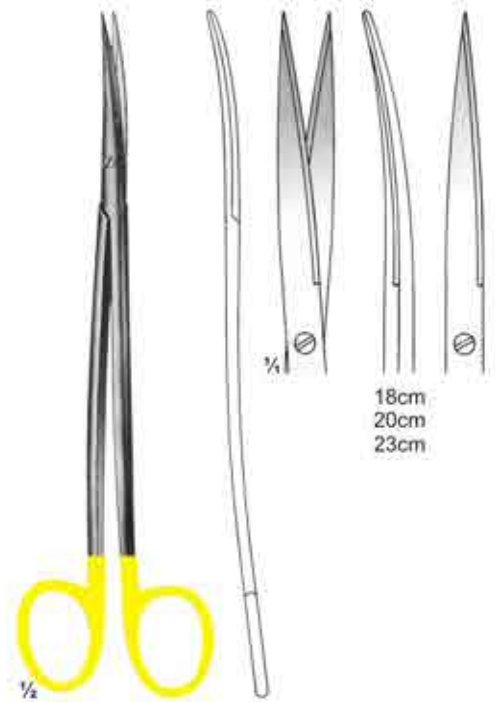

1/4
26-121
 Metzenbaum-Fino

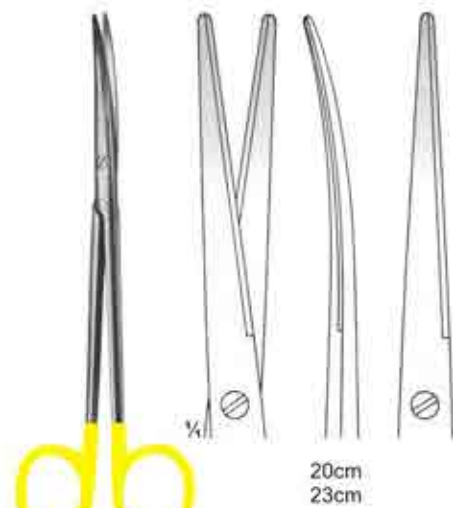

1/4
26-122
 Metzenbaum

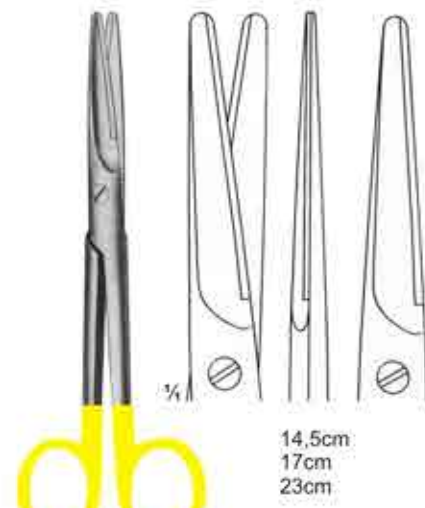

1/4
26-123
 Mayo

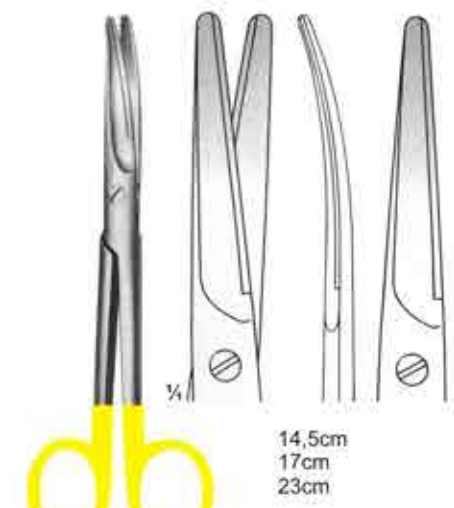

1/4
26-124
 Mayo

Scissors with Tungsten Carbide Inserts

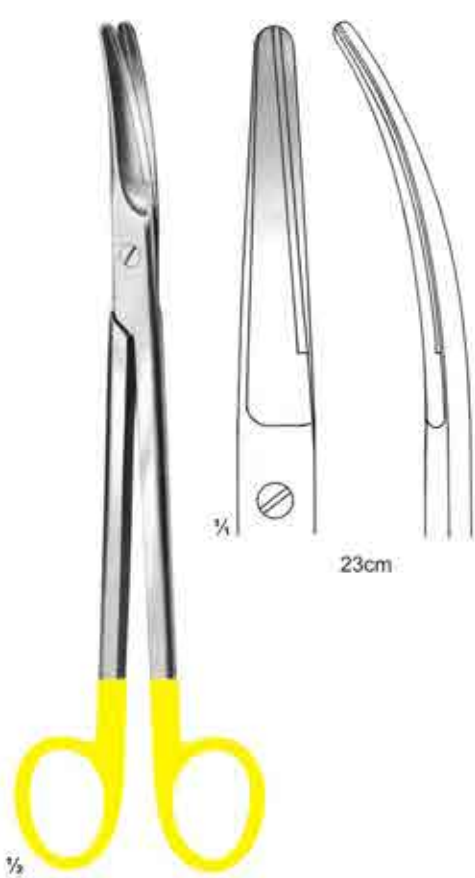

26-125
Parametrium

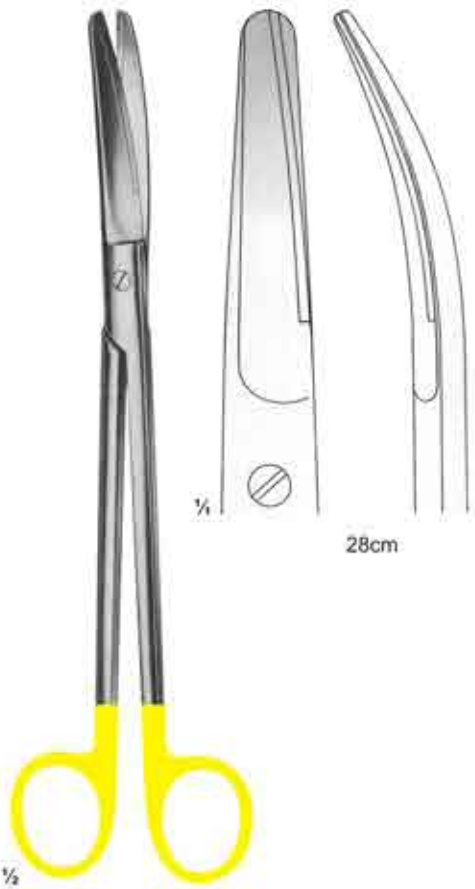

26-126
Mayo-Harrington

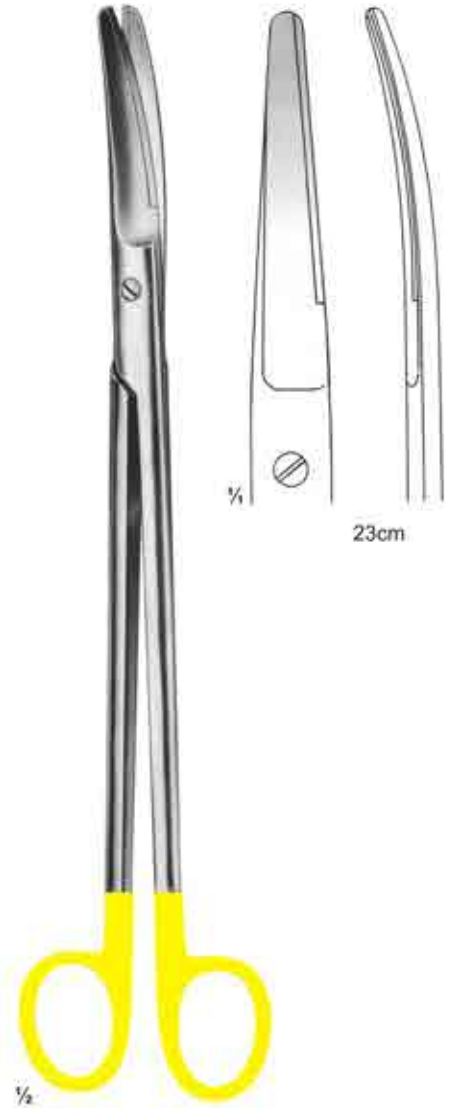

26-127
Sims

Scissors with Tungsten Carbide Inserts

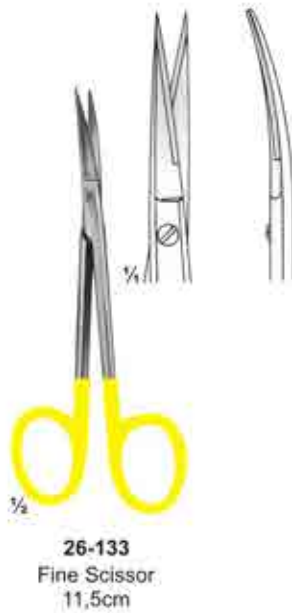
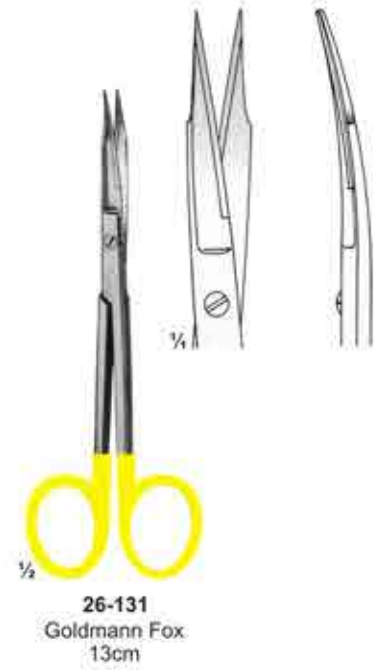

Scissors & Dissecting Forceps with Tungsten Carbide Inserts

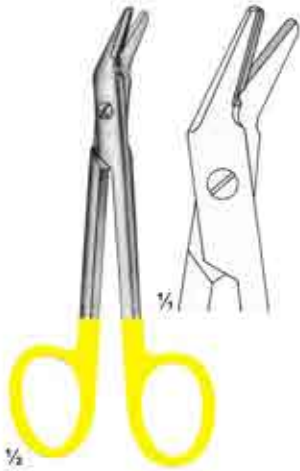

26-136
Universal
12cm



26-137
Ligature Scissors
1 Black & 1 Goldplated ring

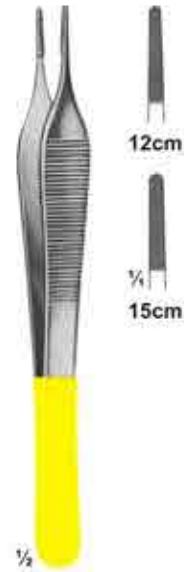

26-138
Adson



26-139
Cushing
17,5cm



26-140
Cushing
18cm



26-141
Cushing-Taylor
18cm



26-142
Dissecting Forceps
15cm



26-143
Semken
15cm

Dissecting Forceps and Needle holders with

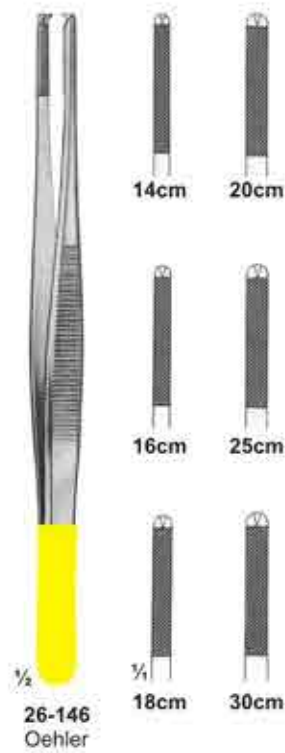
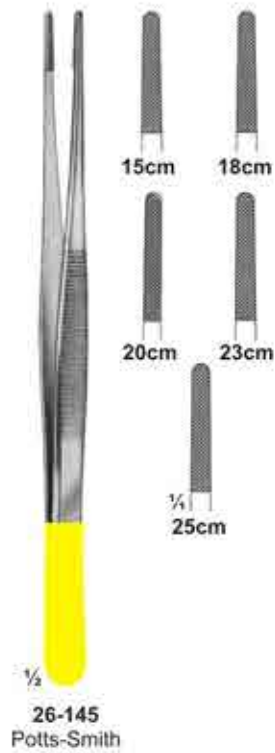

Needle holders with Tungsten Carbide Inserts



26-152
Arruga
16cm



26-153
Castroviejo
13cm



26-154
Hegar
20cm 24cm

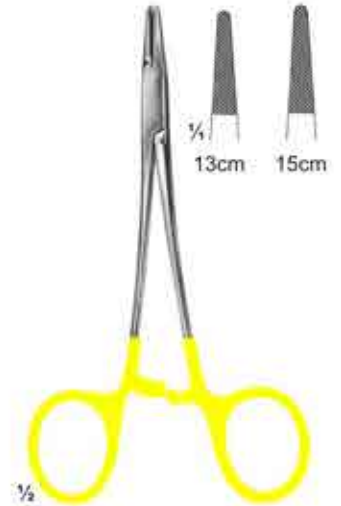

26-155
Halsey
13cm 15cm



26-156
Mayo-Hegar
16cm 18cm 20cm
24cm 26cm 30cm



26-157
De-Bakey
18cm 20cm 23cm
26cm 31cm 37cm

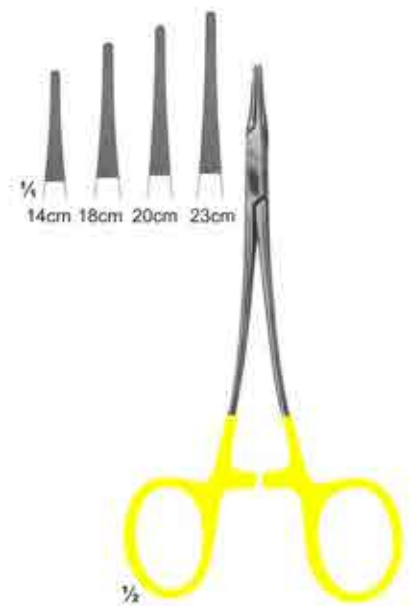

26-158
Hegar-Vascular
14cm 18cm
20cm 23cm

Needle holders with Tungsten Carbide Inserts



1/2
26-159
Bozemann-Wertheim
20cm 24cm 26cm



1/2
26-160
Stratte
22cm 23cm

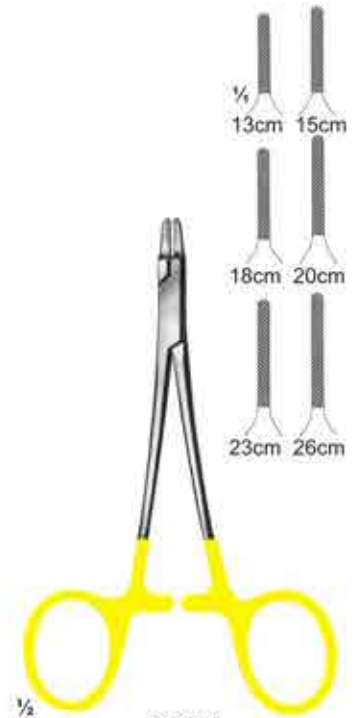

1/2
26-161
Ryder
13cm 15cm 18cm
20cm 23cm 26cm



1/2
26-162
Ryder-Vascular
13cm 15cm 18cm
20cm 23cm 26cm



1/2
26-163
Martin
15cm 17cm 20cm



1/2
26-164
Sarot
18cm 20cm 26cm

Needle holders with Tungsten Carbide Inserts



Needle holders with Tungsten Carbide Inserts



26-172
Mathieu-Ryder
17cm
20cm 24cm



26-173
Lichtenberg
20cm



26-174
Langhals
20cm 25cm



26-175
Lichtenberg
20cm 25cm



26-176
Luehty-Beck
20cm 25cm



26-177
Luehty-Beck
20cm 25cm



26-178
Langebeck
18cm
20cm 23cm



26-179
Langebeck-beck
18cm
20cm 23cm

Wire Cutting Plier With T.C. Inserts



26-180
TOENNIS
 Elastic pattern for
 dura-or intestinal suture
 180 mm



26-181
 Cutting Plier
 12 cm

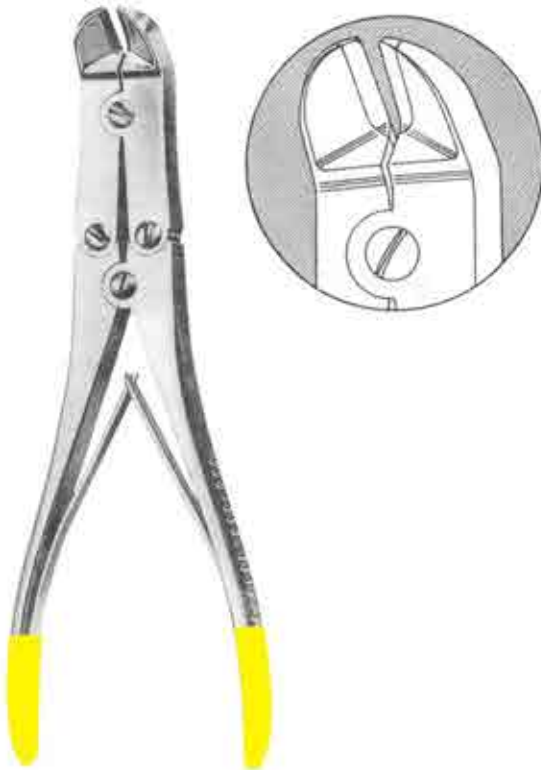

26-182
MULLAR CLAUS
 22 cm



26-183
 Plier
 17.5 cm